

Operator's Instruction Manual

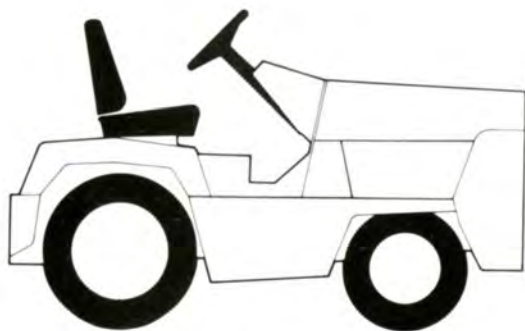

CTA 30 thru 50

CLARK

BOOK NO. OI-343



WARNING

**FOR YOUR SAFETY AND THE
SAFETY OF OTHERS**

BEFORE YOU OPERATE THIS TRUCK!

**READ ALL WARNINGS AND INSTRUCTIONS IN THE
OPERATOR'S MANUAL AND ON THE TRUCK.**

CHECK THE TRUCK FOR CORRECT OPERATION.

**DO NOT OPERATE THIS TRUCK UNLESS YOU ARE
TRAINED AND AUTHORIZED TO DO SO.**

FOREWORD

Federal and state laws require that operators be completely trained in the safe operation of lift trucks.

Before you start operating this lift truck, make sure that you understand all driving procedures. It is important to operate your lift truck safely and efficiently.

This manual will help you learn how to operate your lift truck. This manual describes the controls, special features and the functions of each control.

This manual is not a training manual, it is a guide to help authorized operators safely operate a lift truck. Illustrations in this manual show the operator correct procedures for checking, starting, operating and stopping the lift truck.

Clark lift trucks are built to take hard work, but not abuse. They are built to be dependable but as with any lift truck, they are only as efficient as the operator and the persons responsible for maintaining them.

Do not make any repairs to this truck unless you have been trained in lift truck repair procedures and authorized by your employer.

MANUALES DE INSTRUCCION PARA OPERADORES IMPRIMIDOS EN ESPAÑOL SON OBTENIDOS DE SU DISTRIBUIDOR CLARK.

BETRIEBSANWEISUNGEN IN DEUTSCHER SPRACHE KOENNEN SIE BEI IHREM CLARK-HAENDLER ERHÄLTEN.

MANUELS DE L'OPERATEUR EN LANGUE FRANCAISE PEUVENT ETRE COMMANDES CHEZ VOTRE DISTRIBUTEUR CLARK.

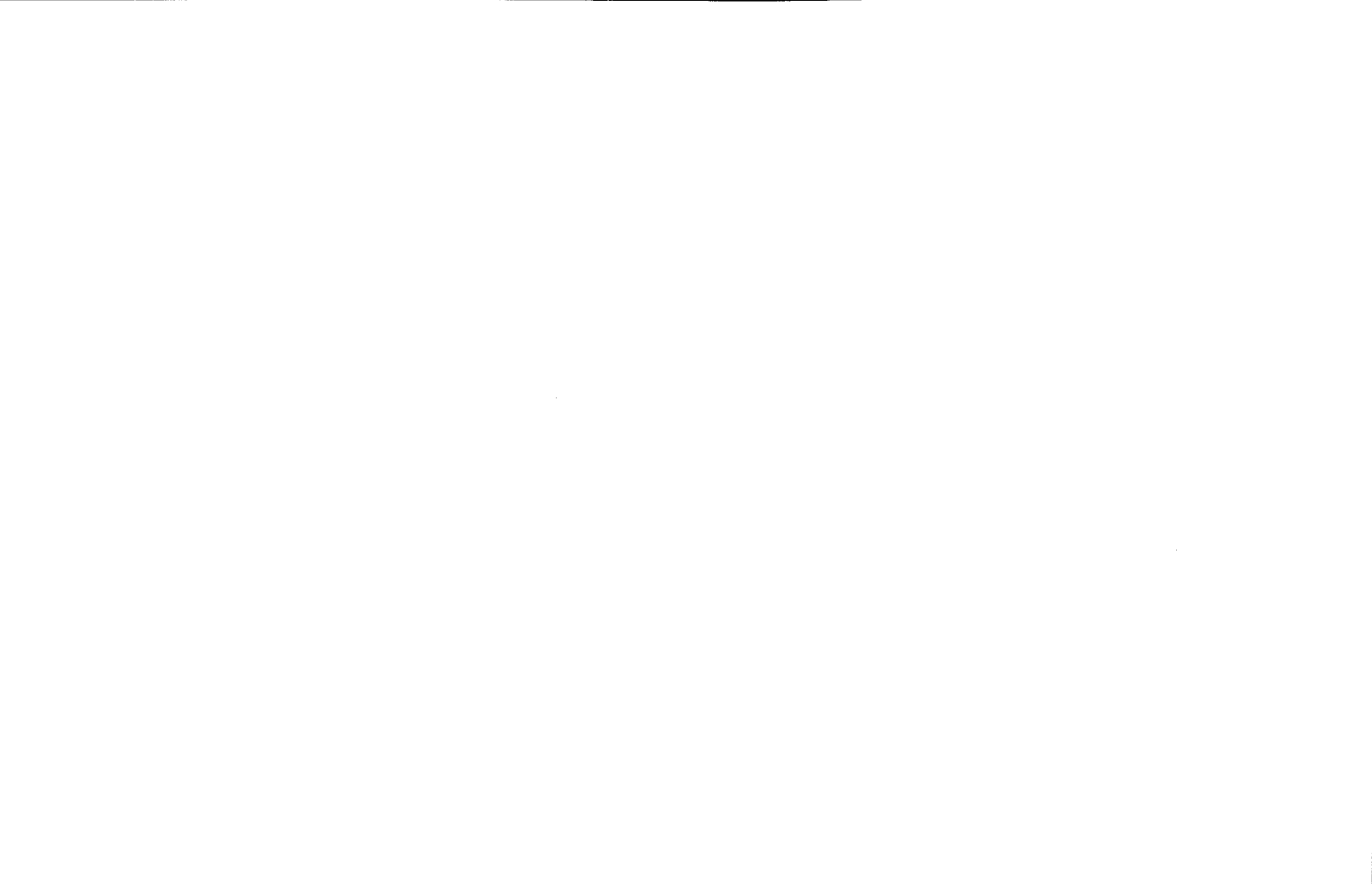

TABLE OF CONTENTS

Operator's Warning	Page 0
Foreword	Page i
Drive Safely	Page iv
Summary of Safe Operating Procedures	Page 1
Know Your Truck	Page 2
Safety	Pages 3-11
Operator's Controls	Page 12
Before Operation	Pages 13-27
Operating Hints	Pages 28-32
Parking	Pages 33-35
Towing Procedures (Disabled Tow Tractors)	Page 36
Wheel and Tire Maintenance	Pages 37-39
Handy Reference Data	Page 40

DRIVE SAFELY

BEFORE YOU OPERATE THIS INDUSTRIAL TRUCK, READ AND UNDERSTAND THE INSTRUCTIONS, SIGNS AND MESSAGES IN THIS MANUAL AND ON THE TRUCK.

INJURY OR DEATH TO YOU OR OTHER PERSONNEL WILL OCCUR IF YOU DO NOT FOLLOW THESE INSTRUCTIONS AND MESSAGES.

STAY ALERT!

SUMMARY OF SAFE OPERATING PROCEDURES

1. Do not operate this truck unless you have been trained and authorized to do so. Read all warnings and instructions in operator's manual and on this truck.

2. Do not operate this truck until you have checked its condition. Give special attention to tires, horn, lights, battery, brakes, steering mechanism, fuel system, and guards.

3. Operate truck only from designated operating position. Never place any part of your body outside of the confines of the truck. Do not carry passengers.

4. Make sure the tow coupling is secure.

5. Do not handle unstable or loosely stacked loads. Use special care when handling long, high or wide loads to avoid losing the load, striking bystanders, or tipping the truck. Loads on trailers must be evenly distributed and secure.

6. Do not overload truck. Check capacity plate for load weight. The safe capacity of a tractor-trailer is its stopping ability, not its potential towing ability.

7. Start, stop, travel, steer and brake smoothly. Slow down for turns and on uneven or slippery surfaces that could cause truck to slide or overturn. Violent application of brakes is dangerous and may cause "jack-knifing" of trailers.

8. When making a turn, allow for "corner-cutting" of the trailer.

9. When moving in reverse direction with a trailer, get assistance if vision is obstructed. Moving in reverse direction with more than one trailer is not recommended.

10. Make sure correct tire pressures are maintained.

11. Before driving over a dockboard or bridge plate, make sure it is correctly secured. Drive carefully and slowly across the dockboard or bridge plate, and never exceed its rated capacity.

12. Do not run over objects on the traveled surface.

13. Use special care when operating on ramps — travel slowly, and do not angle or turn.

14. If a truck must be parked on an incline, put blocks at the wheels.

15. Fumes from operation of engine powered trucks in poorly ventilated areas can be harmful to health. Turn engine off when not in use.

16. Observe applicable traffic regulations. Yield right-of-way to pedestrians. Slow down and sound horn at cross aisles and wherever vision is obstructed.

17. Make a report of all accidents involving personnel, building structures, and equipment to the correct authority.

18. Before getting off truck, neutralize travel control and set parking brake. When leaving truck unattended, turn the ignition circuit off.

Know Your Truck

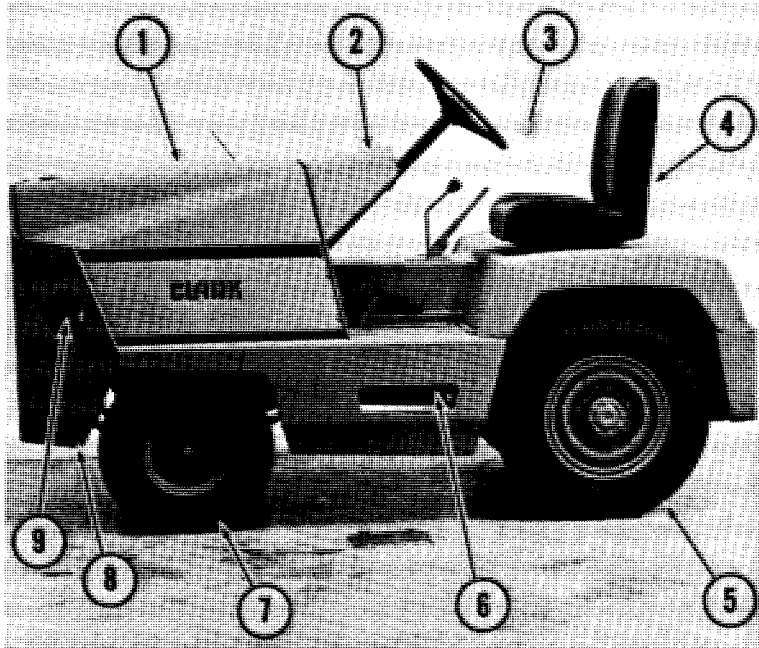

1. Engine Compartment Hood
2. Cowl and Instrument Panel
3. Operators Compartment
4. Operators Seat
5. Drive Wheel and Tire
6. Operators Mounting Step (Left side only)
7. Steer Wheel and Tire
8. Front Bumper Plate
9. Headlight
10. Tail Light

18726

GAS OR DIESEL POWERED TOW TRACTOR

Rated Drawbar Pull Capacities

3000 lbs. (1360 kg), 4000 lbs. (1815 kg), 5000 lbs. (2270 kg).

Safety

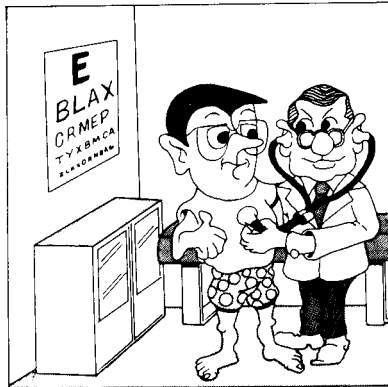

13696

18773

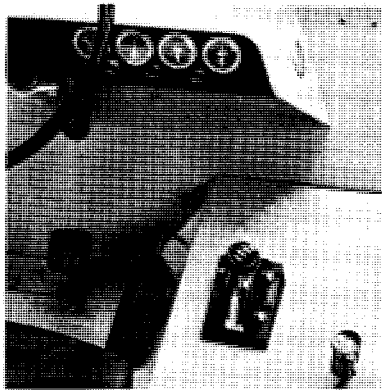

Code: OI-343 OCT 77

1. Only physically qualified and thoroughly trained personnel should be authorized to operate the Clark Gas or Diesel Powered Tow Tractor.

2. Prominently placed on every Clark Tow Tractor is a list of basic rules for operation. These rules are for the protection of you and others in your operating area. Be familiar with them.

3. Learn how your tow tractor is operated. Know its safety devices, how they function and how the special attachments, if any, work.

4. The wearing of "hard hat," safety glasses and safety shoes is recommended. Dress suitably and avoid wearing loose fitting clothing.

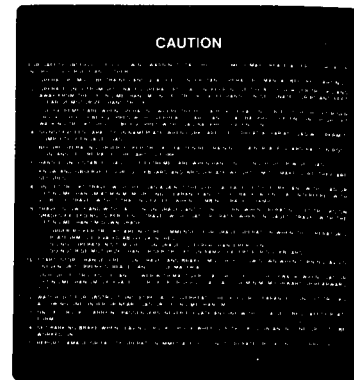

13110

18837



Safety



5. Never attempt to operate a tow tractor with wet or greasy hands or shoes.

18727
18728



7. Always look all around the tractor before moving it in any direction. Remember to start and stop slowly and smoothly. Be especially watchful when backing up to hitch to a load.

6. Before you operate any tow tractor test the horn, service brakes, steering, hand brake, direction controls, lights and any special devices for proper operation. Report any improper operation to the proper authority.

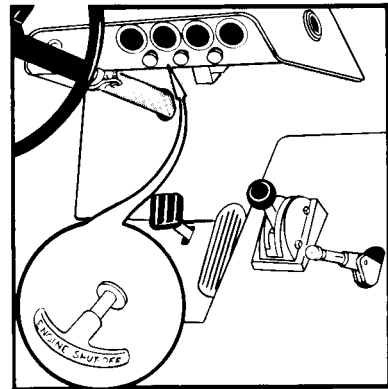

18836
18835

8. Operate the tractor only in designated tractor routes and keep operating aisles clear. One-way traffic is recommended. If this is not practical in your operation heed highway regulations and drive to right of aisle centerline.

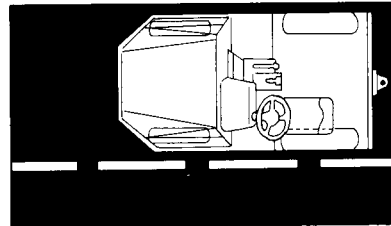
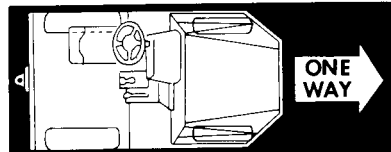

Safety



18729
13087

9. Be alert for pedestrians, other trucks or obstacles in your path of travel.

10. Sound horn at all corners, exits, entrances and when approaching pedestrians or bystanders.

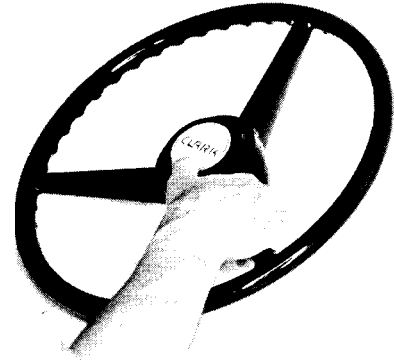

13141
18834



Code: OI-343 OCT 77

11. Obey all posted traffic rules and warning signs.

12. Maintain a safe distance from the tractor ahead of you at all times.

Assure ample distance to stop smoothly and safely should the need arise.

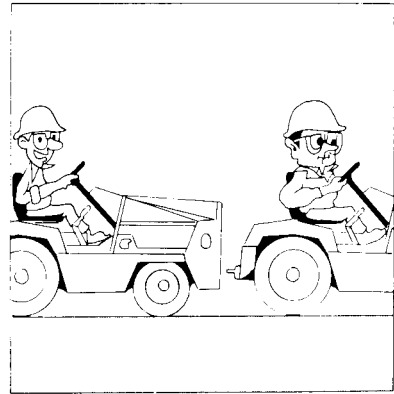

Safety

13. Always be aware of the condition and position of loads being towed. Slow down when in doubt of turn clearance or load stability.

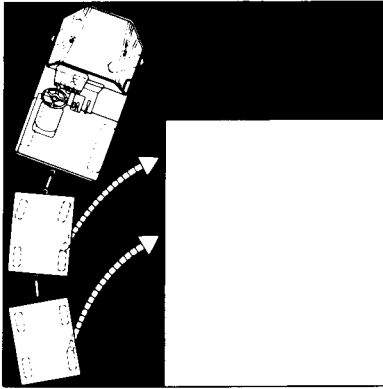

18830
18831

14. Be constantly alert for obstructions in your path of travel to reduce the possibility of striking anything with your front bumper plate or steer tires.



18730
18832

15. Be extremely cautious when operating a tow tractor near the edge of a loading dock, ramp, bridge plate, embankment or ditch.

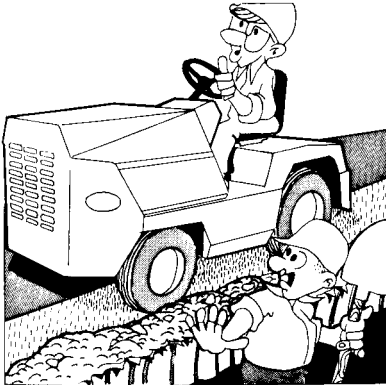

16. Remember to securely block towed load wheels to prevent forward or backward roll **before** you unhitch them from your tow tractor.

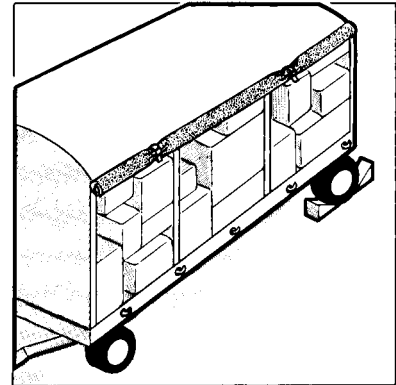

Safety

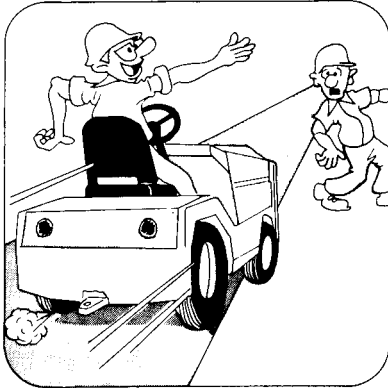

18833
18827

17. Never allow stunt riding or indulge in horseplay while operating a tow tractor.

This is dangerous and could result in serious injury or severe damage to equipment and material.

18. Never allow your tow tractor to be pushed or towed to start.

Should your tow tractor become disabled notify the proper authority.



18826
18616

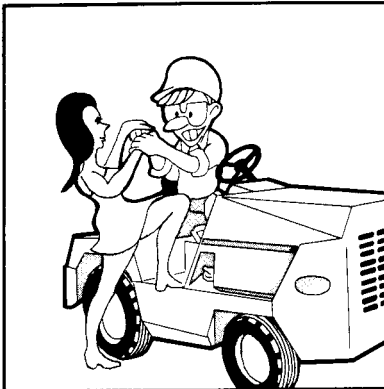

19. Never carry unauthorized passengers. The quick response of a tow tractor may cause riders to fall off. Besides, riders distract you and this is dangerous.

20. Know the rated capacity of your tractor and its attachment (if any) and never exceed it. Study your tractor data capacity plate and learn the facts stamped in areas 1 through 9.

CLARK EQUIPMENT		1	
INDUSTRIAL TRUCK DIVISION BATTLE CREEK MICHIGAN GEORGETOWN KENTUCKY			
MODEL NO.		3	TYPE 4
SERIAL NO.		3	
ATTACHMENTS		5	
LOAD C.G. A B FLOOR	CAPACITY WITH ATTACH LISTED ABOVE OR WITH FORKS - UPRIGHTS VERTICAL		
	LBS	A	B C
	6		
APPROX. WT. ALL TRUCKS	LESS BATT. ELECTRICS		
APPROX. WT. ELECTRICS ONLY	WITH MAX. BATT. WT. 7		
BATTERY WT.	MAX.	MIN.	
BATTERY CAPACITY	A.H. 8	MO.	9
	LBS.	VOLTS	
FOR OTHER CAPACITIES CONSULT MANUFACTURER AS RELEASED FROM FACTORY THIS TRUCK MEETS THE DESIGN SPECIFICATIONS ESTABLISHED IN AMERICAN NATIONAL STANDARD FOR POWERED INDUSTRIAL TRUCKS PART II ANSI B 36.1-1969 PT. NO. 2315709			

Safety

21. Thoroughly inspect the wheels, tires, hitch and safety chains of all wheeled loads to be towed. If you are in doubt as to the mechanical condition of the vehicle to be towed, don't move it.

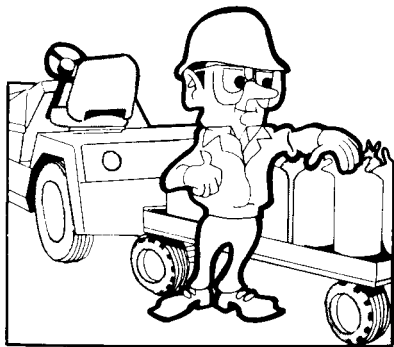

18828
18731

22. Unstable loads are a hazard to you and to your fellow workers. Make certain that your load is well stacked and secure before you move it.

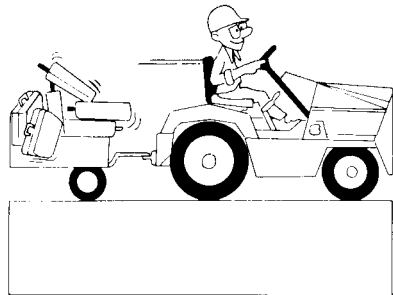

18829
13103

23. Remain seated at all times and keep your head, hands, arms, feet and legs within the confines of the operators compartment.



24. Slow down for turns, ramps, bumps, cross aisles, wet or slippery surfaces and at all times when your visibility is restricted.

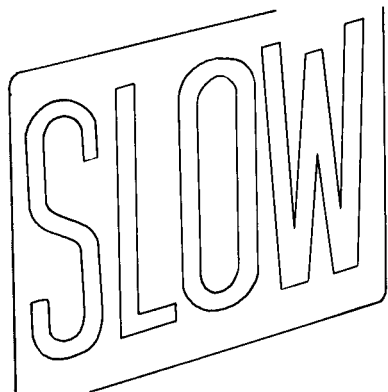

Safety



13102
18822

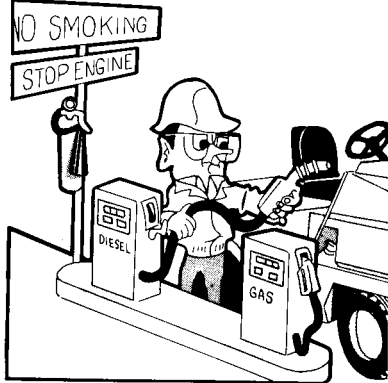

Code: OI-343 OCT 77

25. Know and observe floor load limits, bridge and ramp capacities. Be constantly aware of overhead clearance in all operating areas.

27. Tow tractors must be refueled in designated areas only. Engines must be stopped and no smoking regulations strictly enforced. Spilled fuel must be washed away or completely evaporated and the fuel tank cap properly replaced before restarting the engine.

26. Use caution when towing loads near water pipes, sprinkler systems, electrical wiring, steam pipes, heaters or other fragile or dangerous equipment or material.

28. Never smoke or allow anyone to smoke in areas where batteries are being charged or in areas where fuels or other flammable fluids or materials are used or stored. Batteries must be charged in designated areas only and must be serviced only by thoroughly trained and qualified personnel.

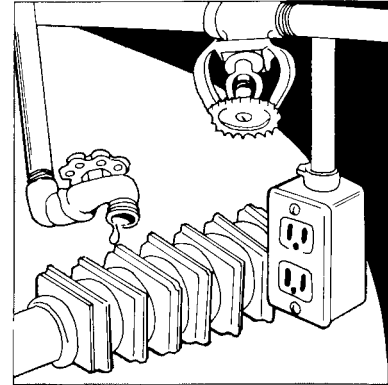

13104
13107

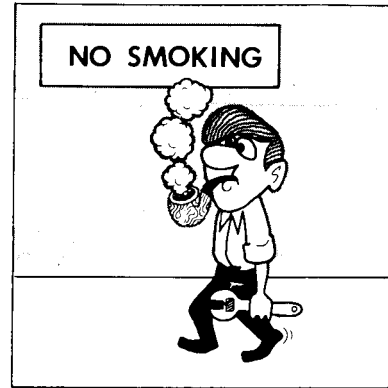

Safety

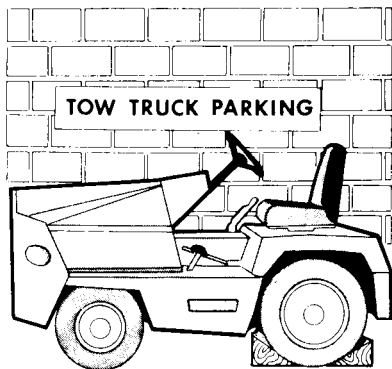

18823

18824

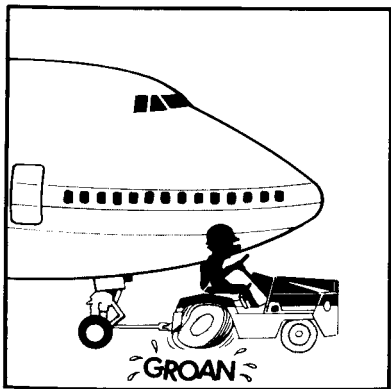

29. Park tow tractors in designated areas only. Place the transmission shift lever in neutral, apply the parking brake, remove the switch key and block the drive wheels to prevent **accidental roll**.

31. Overloading is extremely dangerous. You don't have complete control of your tractor and you are causing unnecessary wear. If you are in doubt as to the weight of your load, don't move it.

30. If the tow tractor is to be left unattended make certain that traffic aisles are unobstructed and leave the tractor as described in item 29.

32. Don't pass other tractors traveling in the same direction at intersections, blind spots or other dangerous locations.

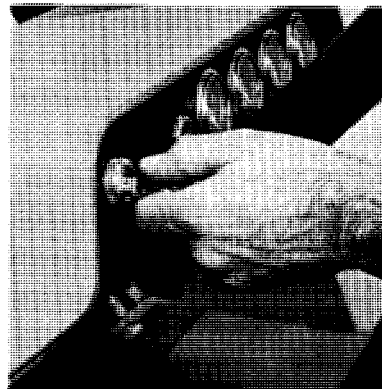

18732

18825

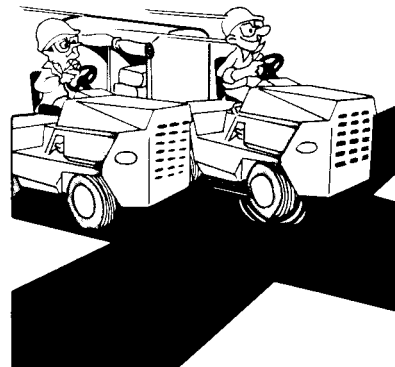

Code: OI-343 OCT 77

Safety

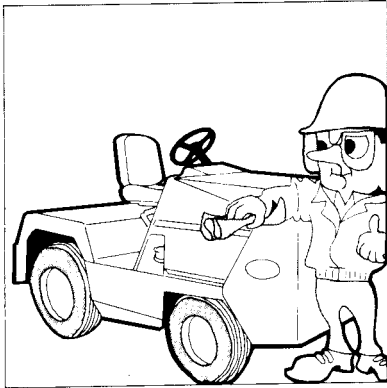

18819
18733

33. Check gauges, horn and all operating controls before you start. Inspect fuel, oil and water levels. Take pride in operating a tow tractor that is clean and in good condition.

34. Report any faulty tractor performance to your supervisor immediately. Don't try to make repairs yourself.

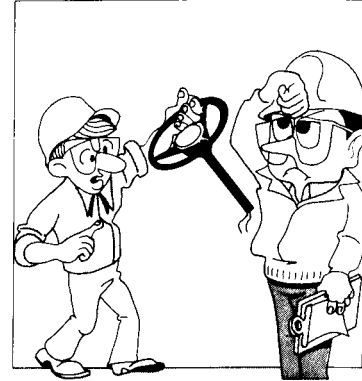

16782
18729



Code: OI-343 OCT 77

35. Follow a scheduled planned maintenance and lubrication program.

All adjustments and repairs must be performed by thoroughly trained and authorized personnel only.

36. Remember — your safety and the safety of others depends on you.



Operators Controls

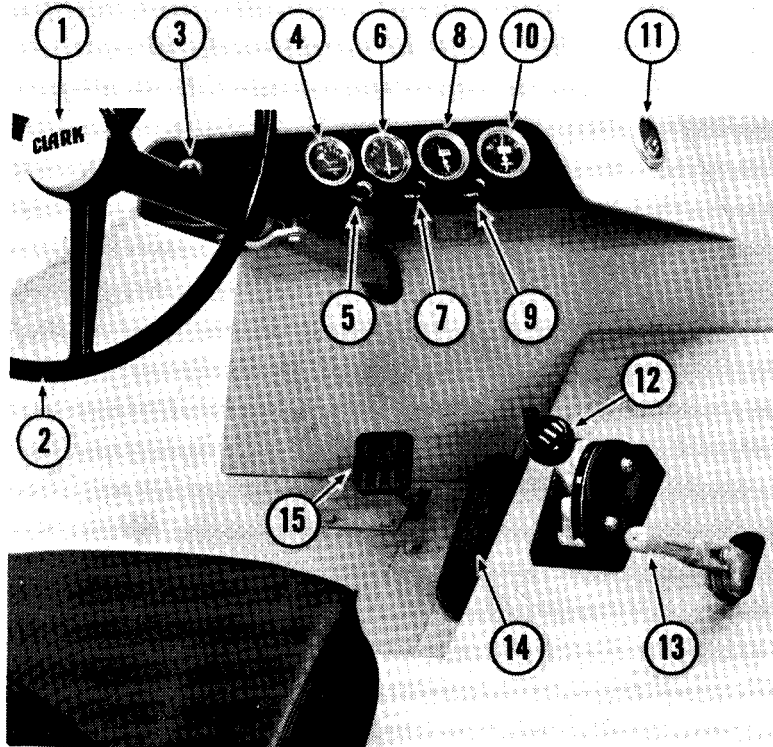

1. Horn Button
2. Steering Hand Wheel
3. Ignition Switch (Partially hidden behind steering column.)
4. Engine Water Temperature Gauge
5. Hand Choke Control (Replaced by engine stop control on diesel powered models.)
6. Engine Oil Pressure Gauge
7. Head and Tail Light Switch
8. Fuel Gauge
9. Back-Up Light Switch
10. Ammeter
11. Engine Hour Meter
12. Transmission Direction Control Shift Lever
13. Parking Brake Lever
14. Accelerator Pedal
15. Service Brake Pedal
16. Cold Start Aid Button (Not shown — located at left of temp. gauge on diesels only.)

Before Operation

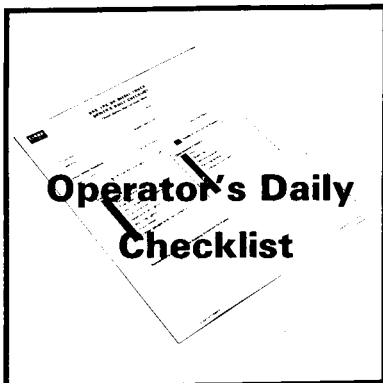

15197
18735

1. Each shift operator must complete an operator's daily check list at the beginning of his shift.

These daily check lists are available from your Clark dealer.

2. Walk around your tractor and visually check for damage and leaks.

Note all damage and leaks on check list.

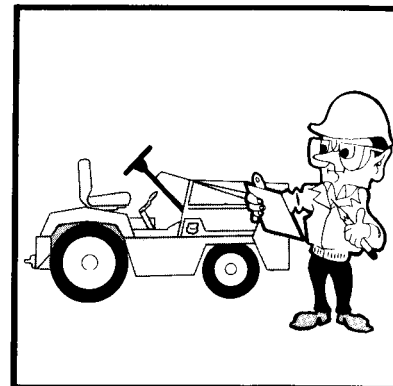

18820
18736



3. Check condition of drive wheels and tires.

Note any apparent drive wheel or tire damage on the check list.

Check drive tire pressure and adjust, if necessary, to pressures listed on page 39.

4. Check condition of steer wheels and tires.

Note any apparent steer wheel or tire damage on the check list.

Check steer tire pressure and adjust, if necessary, to pressures listed on page 39.

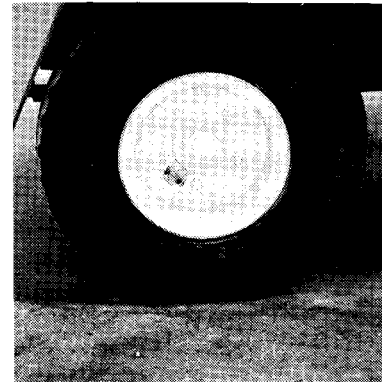

Before Operation

5. Check operation and condition of tail light, stop light, back-up light and head lights.

Note condition of all lights on your check list.

6. Check the mounting and condition of the towing coupler on your tractor. If it is loose or damaged **do not** try to pull a load until repairs are made.

7. Proceed to front of tractor, insert fingers through bumper plate slots and release hood latch. Raise up the front of the hood and push up and back to full open.

8. Make sure the hood is secure in its full open position and then check the general condition of the engine compartment (gas shown)...

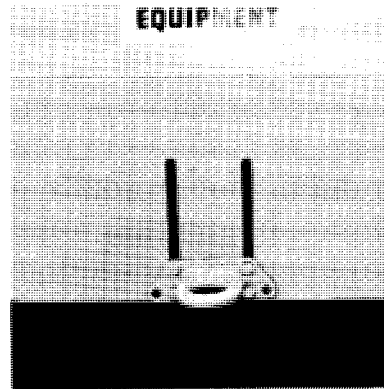
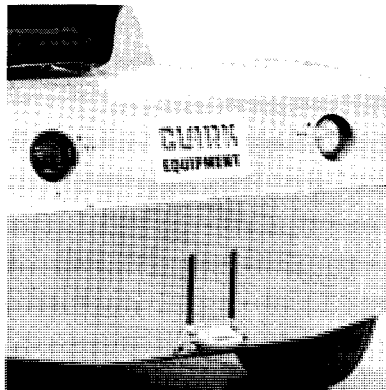

18737
18739

18738
18740

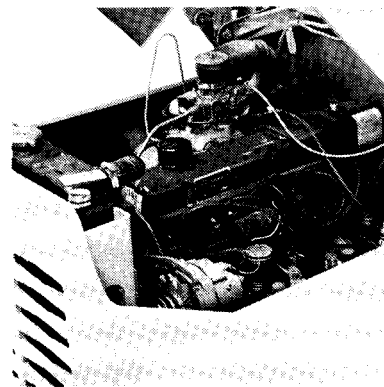

Before Operation

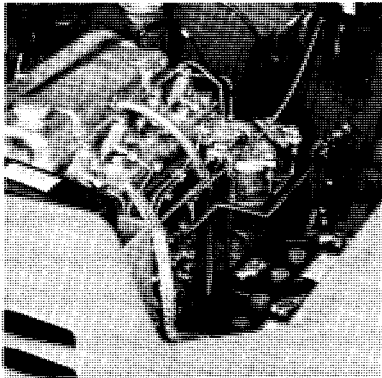

18741
18743

9. . . . (Diesel shown) visually check condition of all belts, wiring, hoses and etc. Note your findings on your check sheet.

10. Diesel powered tractors have the engine oil level dipstick located as shown at right and . .

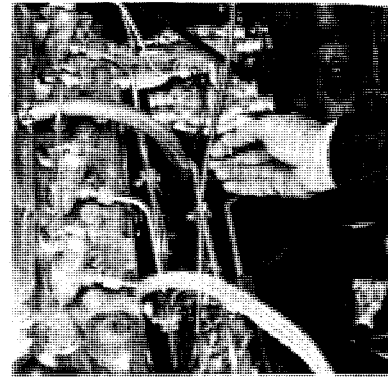

18742
18744



11. . . . the gas powered tractors have the engine oil level dipstick located as shown at left. Pull the dipstick from its support tube. . . .

12. . . . wipe the dipstick with a clean, lint free cloth and then reinsert the dipstick fully into its support tube.



Before Operation

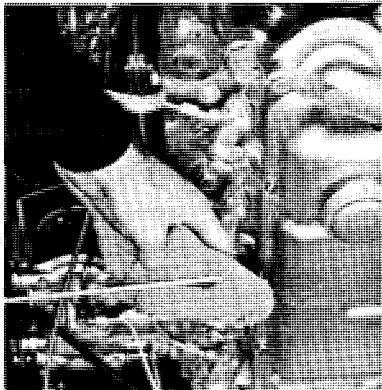

18745
18744

13. Pull the dipstick from its support tube once again and check the oil level indicated on the dipstick.

14. The oil level must be maintained between the "add" and "full" marks on the dipstick. Remember that one quart (1 liter) of oil will change the oil level from "add" to "full". **Do not overfill.**

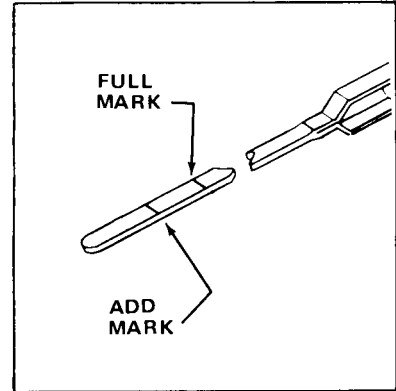

13239
18746

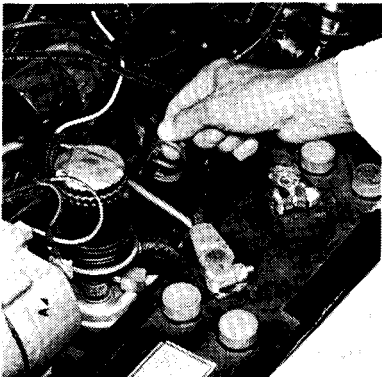

15. Engine oil level should always be rechecked after adding oil.

When oil level has been adjusted to proper level — replace the dipstick making certain that it is inserted fully into its support tube.

16. Battery location on both gas and diesel tractors is the same. Note condition of battery and cables. Check fluid level in **all** battery cells (6 on gas and 6 on diesel).



Before Operation

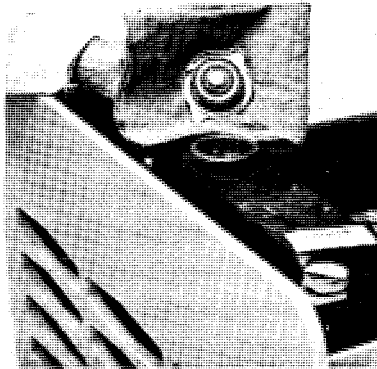

18747

18748



Code: OI-343 OCT 77

17. Always check radiator coolant level with engine turned off and cold, if possible.
Caution — Use extreme care when removing radiator pressure cap. The sudden release of pressure can cause a steam flash resulting in serious injury. Place a rag over the radiator cap and loosen slowly to allow gradual escape of steam.

Never add cold water or cold anti-freeze into the radiator of an overheated engine. Allow the engine to cool and avoid the danger of cracking the cylinder head or block. Keep engine running while adding water or anti-freeze. A solution of 50% ethylene glycol and 50% water is recommended — never use water only.

Replace the radiator cap when you are certain that radiator coolant level has been properly adjusted. Do not close the hood completely at this point.

18. Remove the blocks from the drive wheels, carefully enter the operators compartment and seat yourself in the operators seat.

19. Seat adjustment is accomplished by releasing short lever at lower left side of seat. Position seat to provide easy access to all hand and foot controls, free lever and make certain that seat locks into desired position.

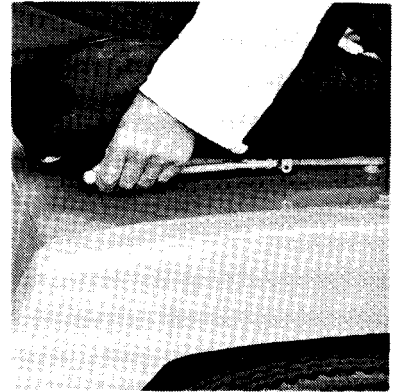

18749

Before Operation

20. If tractor you are operating is diesel powered, make certain that the engine stop lever has been pushed all the way in before you try to start the engine.

NOTE

Current models use a solenoid operated engine shut-off.

22. Check to make certain that the transmission directional control lever is in the neutral position. These tractors are equipped with a neutral start switch and cannot be started in forward or reverse unless switch is faulty or improperly adjusted.

21. Make certain the parking brake lever is in the "on" (full-up) position.

Brake holding power can be adjusted by rotating the knob on top of the lever clockwise to increase holding power or counter-clockwise to reduce it. (See page 32 of this manual for holding specifications.)

23. Gas model tractors are equipped with a manual choke control. This control must be pulled when starting a cold engine and should be pushed in gradually as the engine warms up once started.

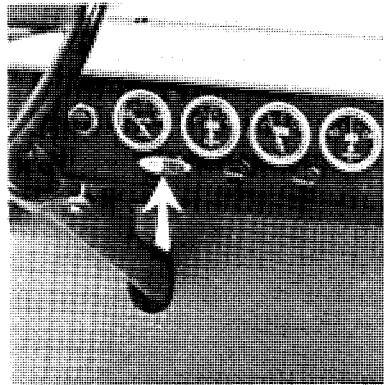

18751

18753

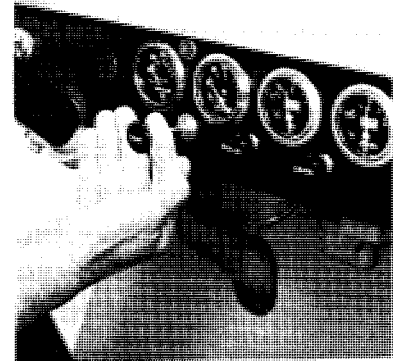

Code: OI-343, REV. MAR. 84

18750

18752

Before Operation

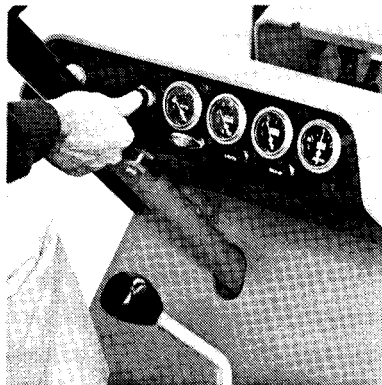

18754

18756

24. Diesel powered tractors are also equipped with a cold weather starting aid. Refer to page 28 of this manual for instructions.

25. Place foot on service brake pedal and apply pressure by pushing down.

Pedal should be "firm." If pedal feels "spongy" or "fades" under pressure DO NOT OPERATE THE TRACTOR. Report brake deficiency immediately to the proper authority.

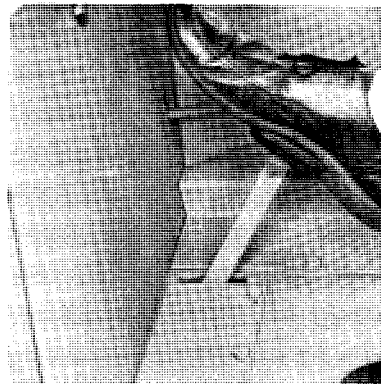

18755

18757

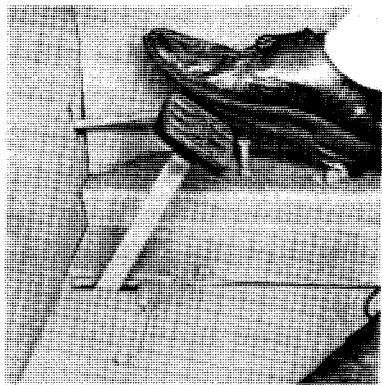

26. Place your right foot on the accelerator pedal.

On gas powered models only slight foot pressure will be required to start the engine.

On diesel powered models push pedal down $\frac{1}{2}$ to $\frac{3}{4}$ of travel to start the engine.

27. Insert switch key into switch and turn key clockwise to the "start" position.

Release key to the "run" position as soon as the engine starts.

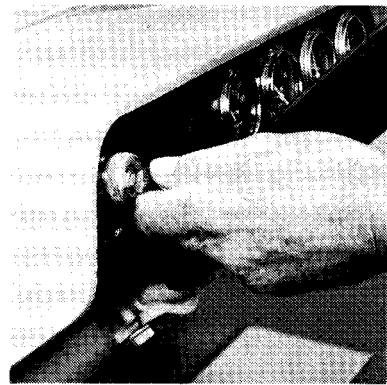

Before Operation



18758

28. If your gas engine becomes overchoked or "flooded" in starting, — push accelerator to floorboard and re-engage the starter as described in item 27.



13222

29. Check the engine oil pressure gauge to insure that it is undamaged and that it is functioning properly.

If engine oil pressure drops below 5 P.S.I. or becomes erratic during truck operation you should immediately shut the engine down until the cause is located and corrected.

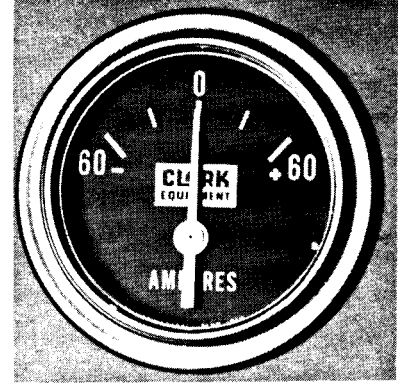

13224

30. Check the ammeter for proper operation. It should indicate in high rate of charge for a short period of time after the engine starts.

If the ammeter shows a continuous high rate of charge, discharge, reads erratically, or is otherwise damaged you should record these facts on your check list.

Before Operation

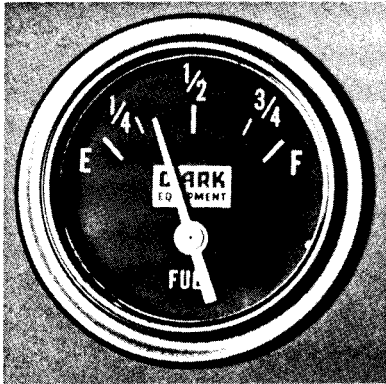

13220

31. Check the fuel gauge to determine the amount of fuel in the tank. Always start your shift with full tank.

Never attempt to start a diesel engine on an empty or near empty tank. To do so may result in serious damage to the injection pump due to lack of adequate lubrication.

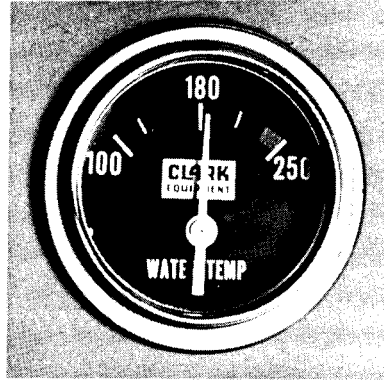

13223

32. Check dash mounted water temperature gauge to insure that it is undamaged and functioning properly. Water temperature should reach 180°F. after 10 minutes of operation.

If the indicator needle goes into the "hot" or red area during operation — immediately shut down the engine and do not restart until cause of trouble has been located and corrected.

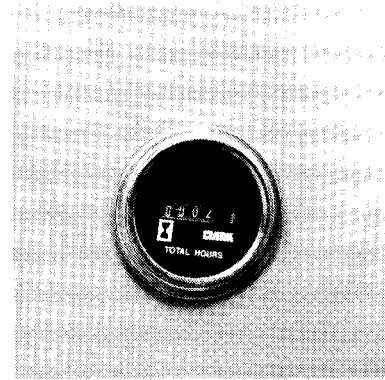

18759

33. Check engine hour meter to insure that it is undamaged and that it is functioning properly.

Record the hour meter reading on your check list.

Before Operation

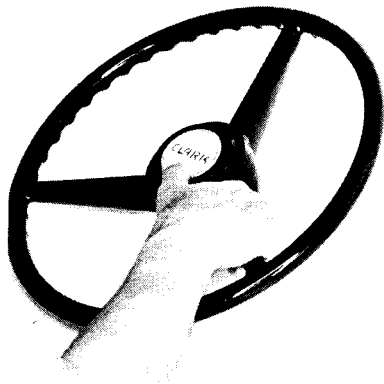

13141
18728

34. Press horn button to determine if horn is operational.

If horn does not function properly record it on your check list and report it to the designated authority when you have completed your "before operation" checks.

35. Rotate steering handwheel to the left and to the right.

Any excessive or unusual free travel, looseness or binding must be noted on your check list.



18760
18755

36. Check all around tractor to make certain that your desired path of travel is unobstructed.

37. Place your right foot on the brake pedal and press down firmly to apply the truck service brakes.

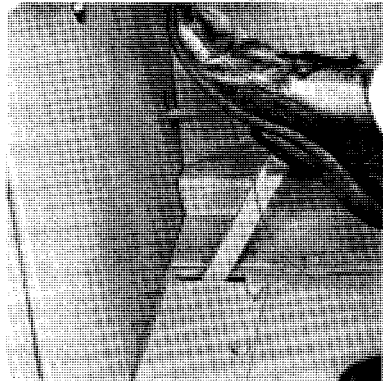

Code: OI-343 OCT 77

Before Operation

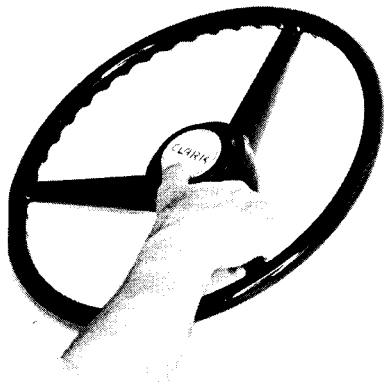

13141
18728

34. Press horn button to determine if horn is operational.

If horn does not function properly record it on your check list and report it to the designated authority when you have completed your "before operation" checks.

35. Rotate steering handwheel to the left and to the right.

Any excessive or unusual free travel, looseness or binding must be noted on your check list.



18760
18755

36. Check all around tractor to make certain that your desired path of travel is unobstructed.

37. Place your right foot on the brake pedal and press down firmly to apply the truck service brakes.

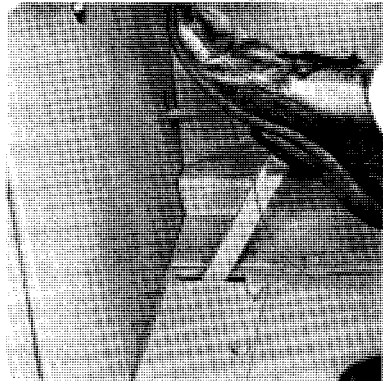

Code: OI-343 OCT 77

Before Operation



38. Release the parking brake by pushing forward on the brake control lever at your right hand side.

18761
18763



40. ... this is newer style. Procedures remain the same regardless of style of directional control lever.

Code: OI-343, REV. MAR. 84

39. Place forward-reverse shift lever into proper position for desired direction of travel. (Pull lever back for forward or push it forward for reverse travel.) Directional control lever may differ from model to model — this is older style, and...

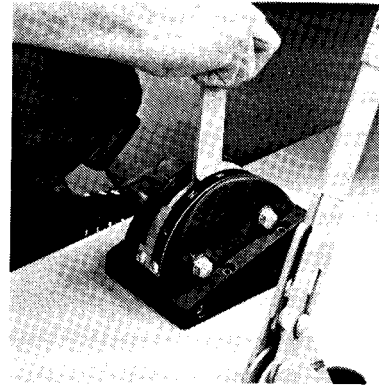

18762
18756

41. Release foot pressure on the brake pedal and place your right foot on the accelerator pedal.

Apply slight downward foot pressure on accelerator pedal until tractor starts to move in the direction you selected in item 39.

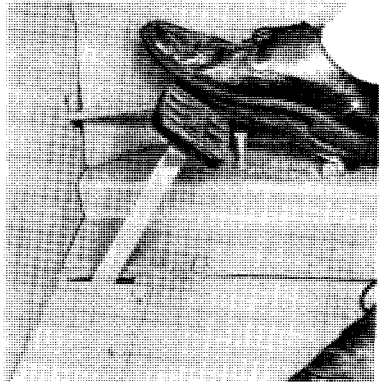

Before Operation

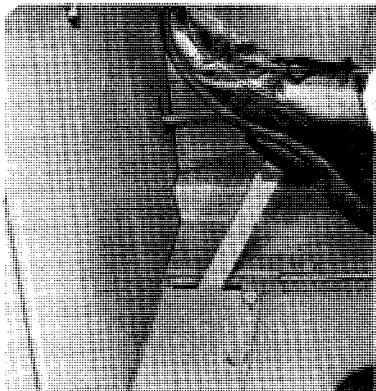

18755
18765

42. Release foot pressure on the accelerator, place right foot on service brake pedal and apply smooth easy downward pressure to bring tractor to a stop.

43. Move the directional control lever into position for travel opposite that selector in item 39 and repeat steps 41 and 42.



18764
18766



44. Move the directional control lever to neutral position. . .

45. . . . apply parking brake by pulling back on hand lever. . . .

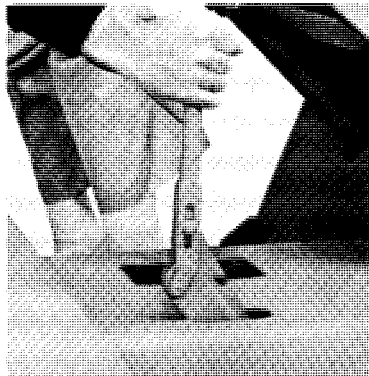

Before Operation

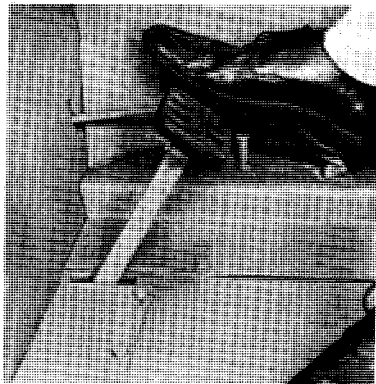

18756

46. . . . run the engine at idle speed for about two minutes and then run it at fast idle (about 1200 rpm) until the engine reaches normal operating temperature (about 170° to 180°).



18748

47. Leave the engine running at idle and carefully get off the tractor.



18767

48. Securely block both drive wheels to prevent accidental roll, walk to front of tractor and open the hood. (Remember you left it unlatched in item 17 on page 17).

Before Operation

49. Transmission dipstick location on diesel powered tractors is as shown at left.

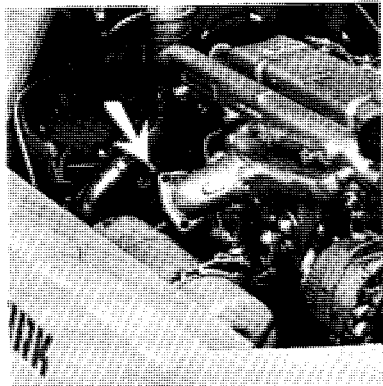

50. Transmission dipstick is located as shown at right on gas powered tractors.

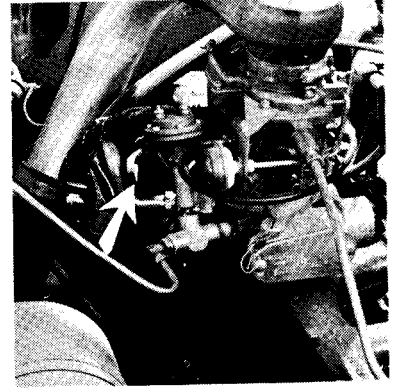

18768
18770

18769
18771

51. Pull the transmission dipstick from its support tube.

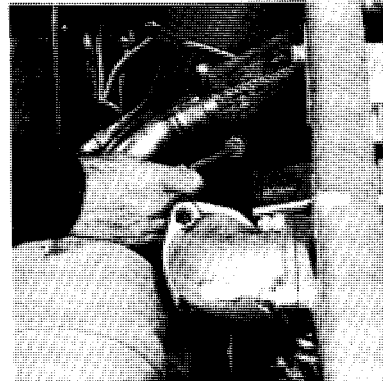

52. Wipe the dipstick dry with a clean, lint free cloth. Insert the dipstick fully into its support tube and pull it out again.



Code: OI-343 OCT 77

Before Operation

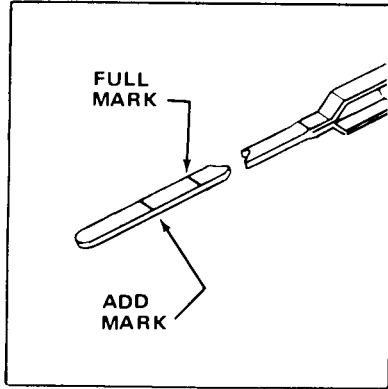

13239
18772

53. Maintain fluid level between "add" and "full" mark on the dipstick. Add only enough ford type "F" fluid to bring level up to full mark — **DO NOT OVERFILL.**

54. Return the dipstick to its support tube and push it all the way in. Close the hood and make certain that it latches shut.

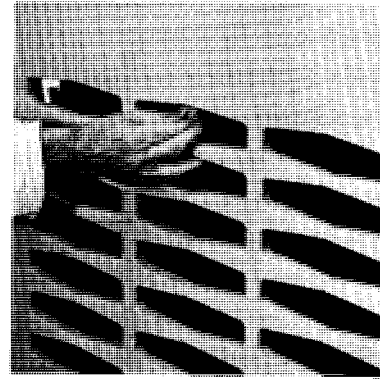

18739
18757

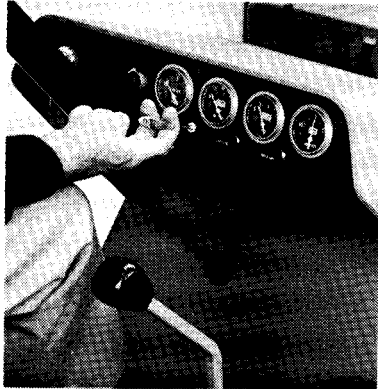

55. If your tractor is diesel powered pull out the engine stop control and hold until the engine stops. Push control into the run position after engine stops.

NOTE

Current models use a solenoid operated engine shut-off.

56. Turn key counter-clockwise to "off" position and remove it. Complete your check-list, date it, sign it and turn it into the designated authority.



Operating Hints

Difficult and Cold Weather Starts — Diesel

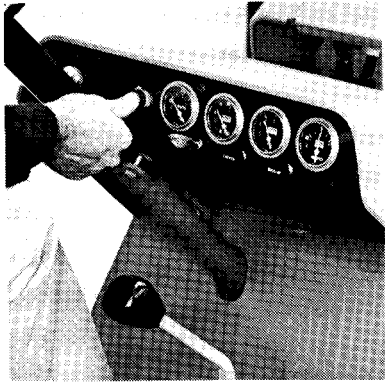

18754

seconds with the key switch in the "run" position. Now crank the engine as outlined in item 3. If the engine does not start, repeat the procedure, holding the heat-start button in for 10 seconds.

At temperatures below 0°F (-18°C), depress the heat-start button for an additional 10 seconds while the engine is running.

If engine fails to start — refer to step 5.

CAUTION — Do not attempt to start engine with empty fuel tank.

1. Make certain that engine "stop" control is pushed all the way into the "run" position.
2. Place the transmission directional control lever in the neutral position.
3. Turn the key switch clockwise to the "start" position and hold for 15 seconds or until the engine starts.
4. If engine does not start, turn key counterclockwise to the "off" position and wait for the engine to come to rest (about 5 seconds).
5. If engine fails to start after 3 attempts, air in the lines may be the cause. Refer to designated authority and consult PMA manual.
6. The Perkins Diesel has a cold starting aid which consists of a manifold heater. If the weather is cold, depress the "heat-start" button for 15

Operating Hints

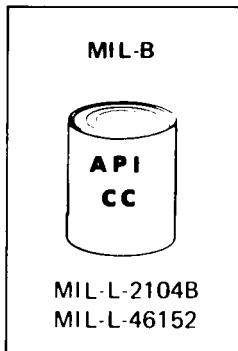

GAS – L.P. GAS ENGINE OIL
SPECIFICATION To meet API Service Classification "CC" and "SC" per SAE Report J183 and/or MIL-L-2104B. Sulfated ash content 1.00% weight maximum. Zinc content 0.06 to 0.10% weight maximum.

This specification includes oils meeting Specification MIL-L-46152 when applicable. Also, API Service "SC"/"SD" (Formerly "MS") oils may be preferred under stop-and-go or light service conditions.

TYPICAL PRODUCT RECOMMENDED BY MAJOR BRAND OIL SUPPLIERS

Chevron RPM DELO Multi-Service Oil
 Shell X-100 or Rotella, Rotella T
 Sunfleet H.P. or Citgo C300 Motor Oil
 ARCO Fleet X.H.D. Motor Oil or ARCO Fleet H.D.
 Gulflube Motor Oil X.H.D.
 AMOCO 200 Motor Oil
 Texaco Havoline or URSA Extra Duty Motor Oil
 Mobil Delvac 1100B or 1200 Series Motor Oil
 ... or the equivalent to the above.

• ENGINE CRANKCASE OIL

RECOMMENDED SAE VISCOSITY NUMBER

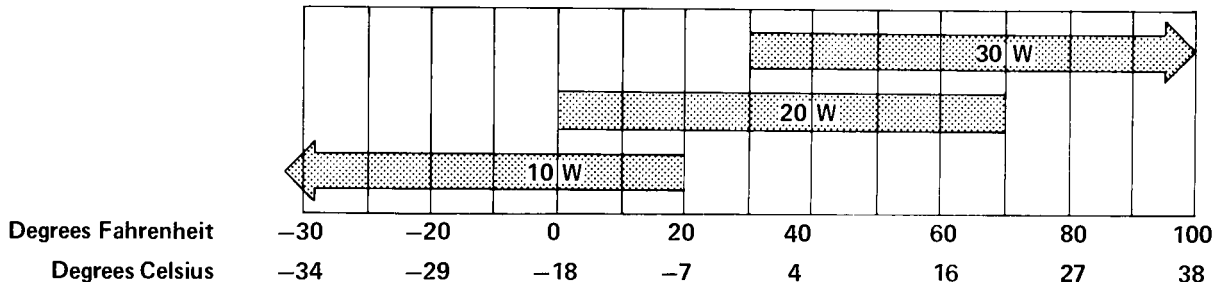

Operating Hints

SERIES 3

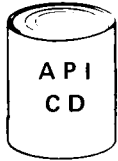

MIL-L-45199B
MIL-L-2104C

For . . . diesel engines using high sulfur content fuel (over 0.5% sulfur).

SPECIFICATION To meet API Service Classification "CD" per SAE Report J183 and equivalent Series 3 and/or MIL-L-45199B specifications. Also MIL-L-2104C when applicable. Sulfated ash content 1.65% maximum.

TYPICAL PRODUCT RECOMMENDED BY MAJOR BRAND OIL SUPPLIERS

Chevron DELO Super 3 Oil
Shell Rimula Motor Oil
Sunfleet S-3 Motor Oil
ARCO Fleet MS-3 Motor Oil
Gulf Super Duty Motor Oil
AMOCO 300 Motor Oil
Citgo C500 Motor Oil
Texaco URSA LA-3 Motor Oil
Mobil Delvac 1300 Series Motor Oil
. . . or the equivalent to the above.

SAE #30 oil of MIL-L-2104B performance level is recommended for year around use in Detroit diesel engines... (Limitations — zinc. 0.10% maximum, sulfated ash 1.0% maximum.). The use of Multi-grade oils in Detroit diesel engines is not recommended.

RECOMMENDED SAE VISCOSITY NUMBER

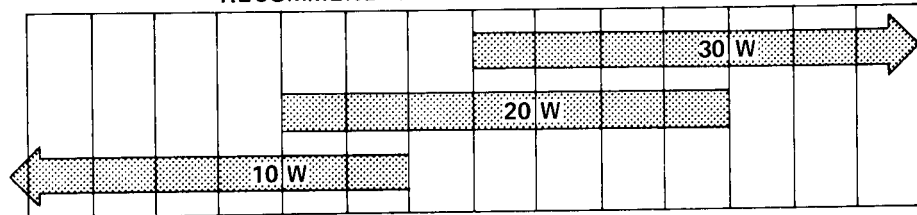

Degrees Fahrenheit

-30

-20

0

20

40

60

80

100

Degrees Celsius

-34

-29

-18

-7

4

16

27

38

Operating Hints



GASOLINE

SPECIFICATIONS Fuel to be Automotive Quality Regular Grade Gasoline containing a corrosion inhibitor.

Minimum Motor Octane
Number – 85

TYPICAL PRODUCT RECOMMENDED BY MAJOR BRAND OIL SUPPLIERS

Shell or Citgo Regular Gasoline
Sunoco 200 or Good Gulf Gasoline
American Regular Gasoline
Texaco Firechief Gasoline
ARCO or Mobile Regular Gasoline
... or the equivalent to the above.

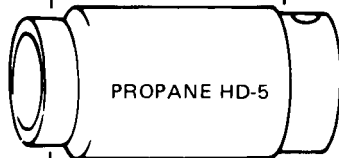

L.P. GAS

SPECIFICATIONS Use LPG meeting PROPANE HD-5 (NGPA Specification 2140-62) or ASTM D2154 (Special Duty Propane) requirements.

Minimum Motor Octane
Number – 95

Citgo L.P. Gas (HD-5)
Texaco 436 Propane
... or the equivalent to the above.

L. P. GAS

DIESEL

SPECIFICATIONS Fuel to be Automotive Quality Diesel Fuel Oil as defined by ASTM D975, Grades No. 1-D and 2-D, and having a sulfur content of less than 0.5% weight.

Recommended Cetane
Number – 45 Minimum

Shell Premium Dieseline OR45
Sun Diesel Fuel 245-T
ARCO Premium Diesel, Diesel #1 or #2
Gulf or Citgo Diesel Fuel #1 or #2
AMOCO Diesel Fuel #1D and American
Premier Diesel Fuel #2D
Texaco Diesel Chief #1
Mobil Fuel Diesel & Diesel Fuel Special
... or the equivalent to the above.

DIESEL

Operating Hints

(

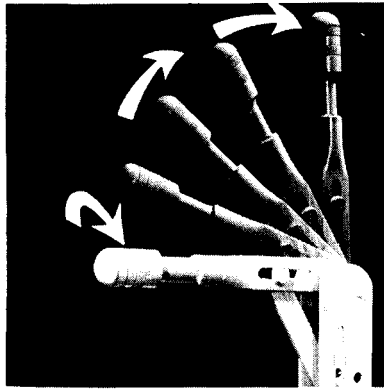

Parking brake performance is checked by moving lever from full "on" position to full "off" position. Maximum force will be required just before brake lever reaches full "on" position.

The parking brake should be adjusted to hold the truck, with capacity load, on a 15% grade (1.5 feet of rise in 10 feet or 45cm of rise in 3m) or on the maximum grade negotiated in your operation, whichever is less. Brake holding power can be adjusted by rotating the knob on the lever. Rotate it clockwise to increase tension or counterclockwise to decrease tension and holding power.

13228

Parking

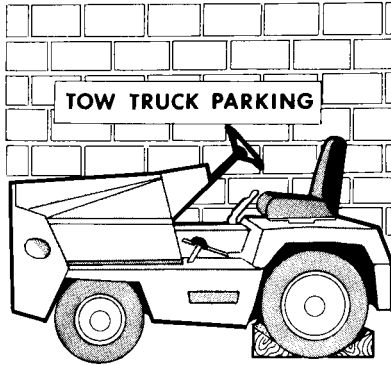

18823

1. Park tow tractors in designated parking areas only.



18765

2. Make certain that transmission directional control lever is in the neutral position.



18766

3. Pull back on brake hand lever to apply parking brake.

Parking



18772

4. If your tractor is diesel powered pull out "engine stop" control and hold until engine stops and comes to rest. Push control into "run" position when engine stops.

NOTE

Current models use a solenoid operated engine shut-off.

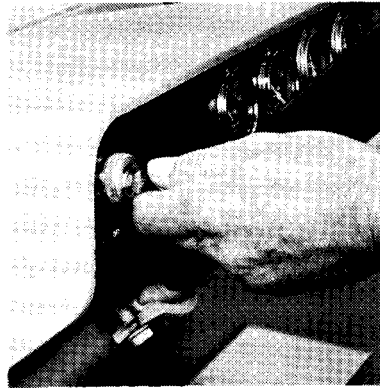

18757

5. Turn ignition switch counterclockwise to the "off" position and remove the key from the switch.



18748

6. Carefully get off the tractor.

PROCEDURES FOR MOVING A DISABLED TOW TRACTOR

The following methods must be used to move an inoperative tow tractor with an **automatic transmission**.

1. Raise the rear wheels off of the ground and move the tow tractor to the maintenance shop.
2. Disconnect the drive shaft and tow the tow tractor to the maintenance shop.

Transmission failure can result if these procedures are not followed.

Wheel and Tire Maintenance

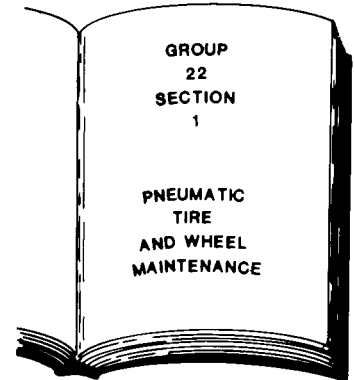
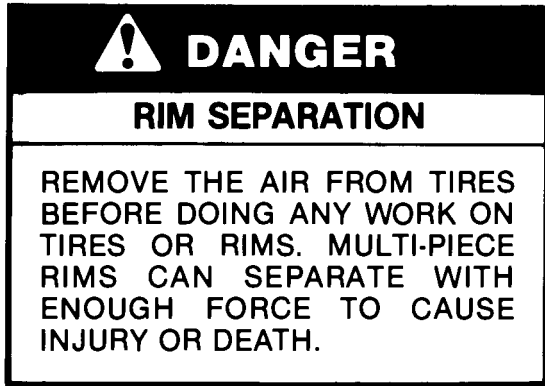

24309

Federal and State laws require persons to be fully trained and qualified before doing maintenance on wheels and tires. Injury or death can result from the explosive separation of rim components if service procedures are not done correctly.

1. Refer to the planned maintenance manual for complete wheel and tire servicing procedures.

Wheel and Tire Maintenance

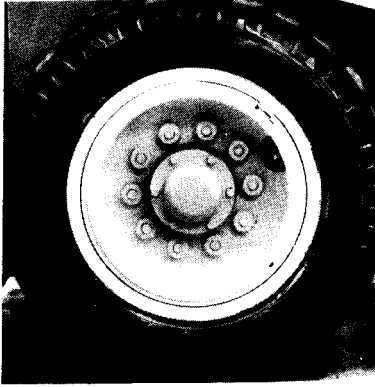

18924

2. Inspect wheels, tires and mounting parts for condition and security daily.

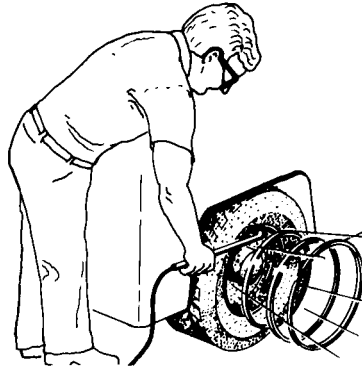

24307

3. Do not stand in front of or in the trajectory path of wheels when checking or adding air pressure. Stand to the side and use a gauge with a long handle and a self attaching air chuck on the hose.

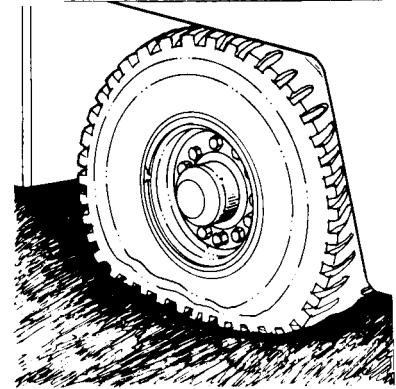

24308

4. Do not put air into a tire which has gone flat or has less than 80 percent of recommended pressure. Check for cause of air loss and confirm that the wheel and tire are safe to use.

Wheel and Tire Maintenance

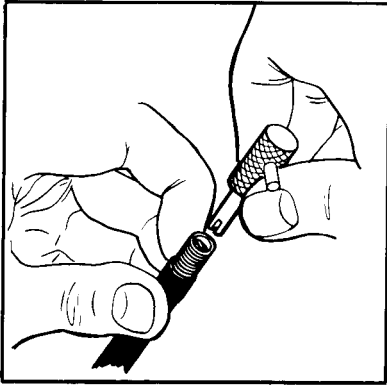

18631

5. Remove air from the tire before moving wheel clamping nuts (two piece wheels) or rim locking rings on multi-piece rims.



24306

6. Always use a safety cage to inflate tires after servicing.
STEER TIRES:
CT30/40/50 . [276 kPa] 40 PSI
DRIVE TIRES:
CT30/40345 [kPa] 50 PSI
CT50[448 kPa] 65 PSI

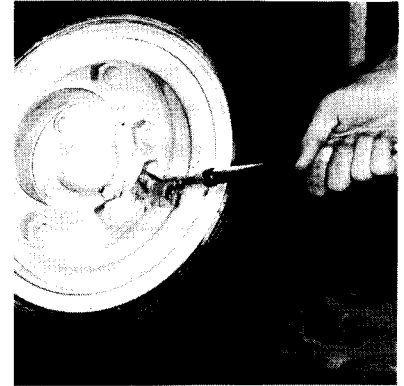

21523

7. Check tire pressure from a position facing the tread of the tire, not the side. Use a long handled gauge to keep your body away from the side.

If tires are low, do not add air. Check with a mechanic. The tire may need to be removed and repaired.

For Handy Reference

RECORD THE FOLLOWING INFORMATION PERTAINING TO YOUR TRUCK

Model No.

Serial No.

Attachments

Truck Weight W/Battery

Truck Rated Capacity

Gross Truck Weight (W/Battery and Rated Load)

Customer Truck Identification No.



Additional copies of this manual may be purchased from
YOUR AUTHORIZED CLARK DEALER

CLARK Industrial Truck
Division

Asheville, NC 28776
Battle Creek, MI 49016
Georgetown, KY 40324
St. Thomas, Ontario, Canada N5P 1H2

7C CGAC FEB 85 Printed in U.S.A.