



INDUSTRIAL TRUCK DIVISION



**OPERATORS  
MAINTENANCE  
PARTS  
MANUAL  
FOR  
C-60**

CODE GOV'T 0-204

**CLARK EQUIPMENT COMPANY**

PUBLISHED BY

TECHNICAL SERVICE DEPARTMENT,  
BATTLE, CREEK, MICHIGAN, U.S.A.



INDUSTRIAL TRUCK DIVISION



OPERATORS

MAINTENANCE

PARTS

MANUAL

FOR

CY-60

CLARK EQUIPMENT COMPANY

PUBLISHED BY

TECHNICAL SERVICE DEPARTMENT  
BATTI, CREB, WICHMAN, U.S.A.

## ***SAFETY INSTRUCTIONS*** FOR MAINTAINING INDUSTRIAL TRUCKS

Powered industrial trucks may become hazardous if adequate maintenance is neglected. Therefore, adequate maintenance facilities, personnel and procedures should be provided.

Maintenance and inspection of all powered industrial trucks should be performed in conformance with the recommendations in this Manual and the following practices:

1. Only qualified and authorized personnel should be permitted to maintain, repair, adjust, and inspect industrial trucks, and a scheduled preventive maintenance, lubrication, and inspection system should be followed.
2. When truck is to be parked for maintenance: Turn off engine, lower lifting mechanism, place directional controls in neutral, (clutch type trucks may be left in gear) apply parking brake and chock wheels.
3. Before working on truck raise wheels free of floor or disconnect power source. Use chocks or other positive truck positioning devices and block carriage, innermast(s), or chassis before working under them. Before working on engine fuel system of: (a) Gasoline powered trucks with gravity feed fuel systems, be sure fuel shutoff is closed; (b) LP gas powered trucks, close LP-gas cylinder valve and run engine until fuel in system is depleted and engine dies.
4. When starting engine place shift levers in neutral and depress clutch (or brake pedal on automatic transmissions).
5. Avoid fire hazards and have fire protection equipment present. Do not use an open flame to check level, or for leakage, of fuel, electrolyte or coolant. Do not use open pans of fuel or flammable cleaning fluids for cleaning parts.
6. Properly ventilate work area, vent exhaust fumes and keep shop clean and floor dry.
7. Use hoisting equipment for heavy lifts.
8. Handle LP Gas cylinders with care. Do not drop, dent, or damage in any way.
9. Brakes, steering mechanisms, control mechanisms, warning devices, lights governors, lift overload devices, safety guards and safety devices should be inspected regularly and maintained in a safe operating condition.
10. All parts of lift and tilt mechanisms and frame members should be carefully and regularly inspected and maintained in a safe operating condition.
11. Special trucks or devices designed and approved for hazardous area operation should receive special attention to ensure that maintenance preserves the original approved safe operating features.

*(Continued)*

## ***SAFETY INSTRUCTIONS*** FOR MAINTAINING INDUSTRIAL TRUCKS

12. Fuel systems should be checked for leaks and condition of parts. Extra special consideration should be given in the case of a leak in the fuel system. Action should be taken to prevent the use of the truck until the leak has been corrected.
13. All hydraulic systems should be regularly inspected and maintained in conformance with good practices. Tilt cylinders, valves, and other similar parts should be checked to assure that "drift" has not developed to the extent that it would create a hazard.
14. Capacity rating, operation and maintenance instruction plates, tags, or decals should be maintained in legible condition.
15. Batteries, motors, controllers, limit switches, protective devices, electrical conductors and connections should be inspected and maintained in conformance with good practices. Special attention should be paid to the condition of electrical insulation.
16. Industrial trucks should be kept in a clean condition to minimize fire hazards and facilitate detection of loose or defective parts.
17. Modifications and additions which affect capacity rating and safe operation should not be performed by the user without manufacturer's approval.
18. Care should be taken to assure that all replacement parts are interchangeable with the original parts and of a quality equal to that provided in the original equipment.



# INDUSTRIAL TRUCK DIVISION



P L E A S E       N O T E

I N S T R U C T I O N S       O N       U S E       O F       M A N U A L

This Operator's Manual is published as a service reference guide and includes Specifications, Operating Instructions, Lubrication and Preventive Maintenance Instructions, and Trouble Shooting Guide.

The TABLE OF CONTENTS for this manual is printed on green paper and is placed at the front for easy reference. A separate INDEX (also printed on green paper) is placed in front of the Lubrication and Preventive Maintenance Section.

Lubrication and Preventive Maintenance Instructions are listed under the TIME INTERVALS that they should be performed.

The TIME INTERVAL is part of the page number and code number.

Example: 8H 002-0; 8H is the TIME INTERVAL (8 operating hours), 002 is the PAGE NUMBER, and -0 is a CODE NUMBER that you as a customer should disregard. The dash number or code number is for the benefit of the publisher only.

The INDEX is set up under the TIME INTERVALS that the Lubrication and Preventive Maintenance should be performed.

Example: (8 Hours)	Time Interval & (H=Hours)	Page Number (000-)
Hydraulic Sump Tank, level check...	8H	503
Brake Pedal Free Travel, check.....	8H	303

The above states to check the sump tank fluid level every 8 operating hours and refer to page 503 for fluid recommendations etc. Also, to check brake pedal free travel at this interval and turn to page 303 for instructions.

Turn to the eight (8) hour section (8H) and then to the page listed — 503 or 303 etc. The instructions covered therein will pertain only to the checks or adjustments that should be performed at this TIME INTERVAL.

If, for instance, the Brake Pedal Free Travel is incorrect, you would then refer to the INDEX for "Brake Pedal Free Travel, adjust" which would be listed in the TIME INTERVALS following the 8 hour section.

<u>Example:</u> (100 Hours)	Time Interval & (H=Hours)	Page Number (000-)
Brake Pedal Free Travel, adjust....	100H	302

Turn to the one hundred hour section (100H) and then to



# INDUSTRIAL TRUCK DIVISION



(continued)

## I N S T R U C T I O N S   O N   U S E   O F   M A N U A L

page 302. Complete instructions as to the importance of pedal free travel, the method to check and adjust for correct free travel with illustrations are included therein.

### N O T E

YOU WILL NOTE THAT AT THE BEGINNING OF EVERY SECTION A LUBRICATION AND PREVENTIVE MAINTENANCE ILLUSTRATION IS SHOWN GIVING THE LOCATION OF THE COMPONENTS TO BE SERVICED.

It is impossible to cover all types of machine operations in one manual. Operating conditions should determine the lubrication and maintenance intervals. Common sense and a close observance can best determine the frequency with which you should service your machine.

The care you give your machine will greatly determine the satisfaction and service life that you will obtain from it. A definite maintenance program should be set up and followed. Haphazard maintenance will only lead to faulty performance and short life.



# INDUSTRIAL TRUCK DIVISION



## TABLE OF CONTENTS

<u>Page</u>	<u>Description</u>
A001	Instructions on use of manual
A002	Instructions on use of manual
A003	Table of contents
A004	Table of contents
1077-Z	Serial number location
B002	Specifications
B003	Specifications
B005	Specifications
B006	Specifications
B007	Specifications
B008	Specifications
B031	New machine 50 hour inspection

### OPERATIONS

C002	Overall Controls
C003	Instrument indicators
C004	Instrument indicators
C103	Starting instructions
C303	Safety precautions

### LUBRICATION AND PREVENTIVE MAINTENANCE

<u>Time Interval (H=Hours)</u>	<u>Page Number (0000)</u>	<u>Description</u>
H	001	Index
8H	000	<u>8 Hour Lubrication and Preventive Maintenance Illustration</u>
8H	001	Location of Fuses and Fuel Tank Check
8H	002	Engine crankcase check
8H	103	Engine cooling system check
8H	203	Instrument indicators check
8H	204	Instrument indicators check
8H	303	Brake pedal free travel, parking brake check
8H	403	Air Cleaner check
8H	503	Hydraulic sump and control levers check
8H	602	Tire and rim maintenance
8H	603	Tire and rim maintenance
8H	703	Power Steering pump
100H	000	<u>100 Hour Lubrication and Preventive Maintenance Illustration</u>
100H	001	Converter, Transmission and Axle Adapter
100H	002	Engine crankcase and oil filter check
100H	103	Cooling System check
100H	203	Fan and Generator drive belt check
100H	302	Brake System check, Brake pedal free travel check
100H	303	Master cylinder check
100H	403	Lifting mechanisms check
100H	503	Hydraulic sump tank breather
100H	603	Steering gear and battery check
100H	604	Battery check
100H	703	Lubrication check



# INDUSTRIAL TRUCK DIVISION



## TABLE OF CONTENTS

### LUBRICATION AND PREVENTIVE MAINTENANCE

Time Interval (H=Hours)	Page Number (0000)	Description
500H	000	<u>Lubrication and preventive maintenance illustration</u>
500H	001	Fuel Pump Filter Check
500H	002	Transmission oil filter, screen, and level check
500H	004	Axle adapter & transmission drain plugs
500H	103	Hydraulic sump tank and filter check
500H	202	Steering gear adjust
500H	203	Steering gear adjust
500H	302	Steering axle and linkage adjustments
500H	303	Steering axle and linkage adjustments
500H	403	Manifolds check
1000H	000	<u>Lubrication and Preventive Maintenance Illustration</u>
1000H	001	Engine Tune up
1000H	002	Cylinder head, manifolds, crankcase, and valves adjustments
1000H	003	Valve adjustment
1000H	103	Compression test
1000H	203	Distributor Adjustments
1000H	204	Distributor adjustments
1000H	303	Distributor adjustments and timing
1000H	304	Timing
1000H	403	Vacuum Test
1000H	503	Governor adjustment
1000H	504	Governor adjustment
1000H	603	Starting motor
1000H	604	Starting motor
1000H	703	Generator adjustment
1000H	704	Generator adjustment
1000H	803	Steer wheel bearings lubrication
1000H	805	Axle ends lubrication
1000H	912	Brake bleeding procedure
1000H	913	Brake Bleeding procedure
1000H	1003	Brakes service
1000H	1103	Hand Brake adjustment
1000H	1202	Cooling System inspect and clean
1000H	1203	Cooling System inspect and clean
1000H	1503	Hydraulic system check
1000H	1504	Hydraulic system check
1000H	1505	Hydraulic system check
1000H	1507	Hydraulic system check
1000H	1703	Transmission stall and pressure checks
1000H	1704	Transmission stall and pressure checks
1000H	1705	Battery check
1000H	1793	Neutral starting switch
1000H	1803	Lift and upright adjustments
1000H	1806	Roller adjustments
1000H	1807	Upright roller adjustments
1000H	1808	Upright roller adjustments
1000H	1811	Lift carriage roller adjustments
1000H	1815	Upright roller lubrication

### TROUBLE SHOOTING GUIDE

Page	Description	Page	Description
TS 001	Engine	TS 483	Drive Axle
TS 251	Fuel System	TS 251	Steering Axle
TS 321	Cooling System	TS 531	Steering
TS 341	Ignition System	TS 541	Brakes
TS 361	Starting Motor	TS 653	Hydraulic System
TS 381	Generator troubles	TS 963	Transmission, Converter and Axle Adapter (Hydrator Drive)
TS 401	Battery, Lights and Horn		





Plate 9474. Machine Serial No. Location

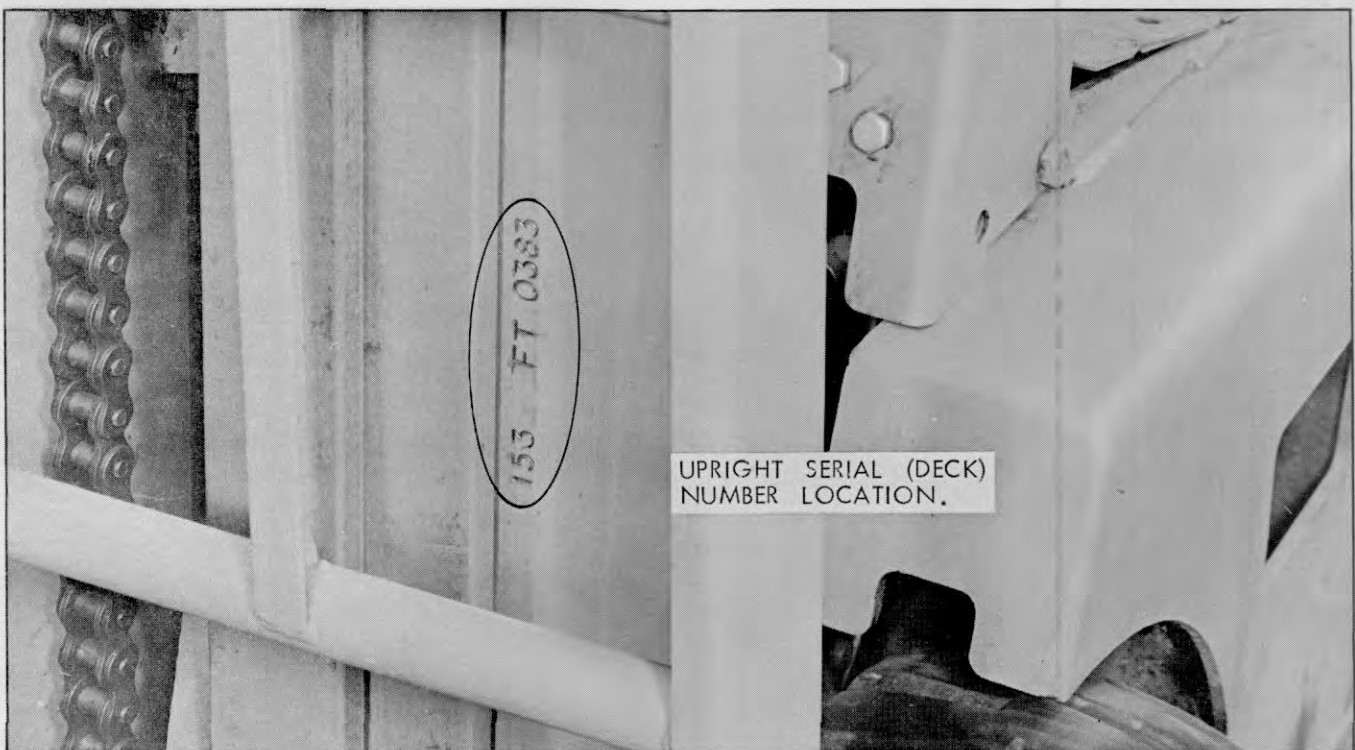

Plate 9475. Upright Serial (Deck) No. Location



INDUSTRIAL TRUCK DIVISION



OPERATORS

MAINTENANCE

PARTS

MANUAL

FOR

CY-60

CLARK EQUIPMENT COMPANY

PUBLISHED BY

TECHNICAL SERVICE DEPARTMENT  
BATTI, CREB, WICHMAN, U.S.A.

**CLARKLIFT®**  
**C-60**

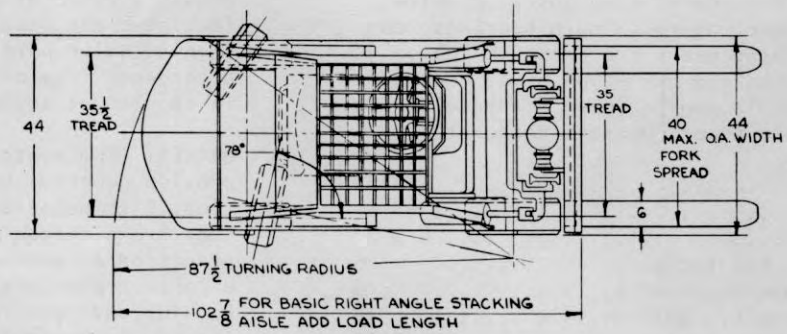

**CAPACITY CHART**

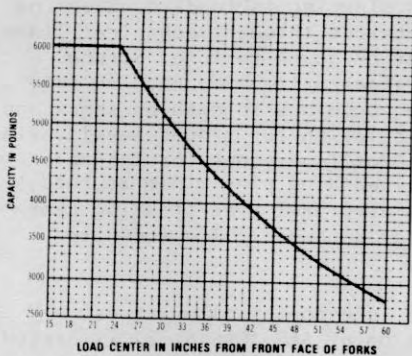

LOAD CENTER IN INCHES FROM FRONT FACE OF FORKS  
RATED CAPACITIES SHOWN ABOVE ARE COMPUTED WITH UPRIGHTS IN VERTICAL POSITION

**GRADE & DRAWBAR PULL CHART**

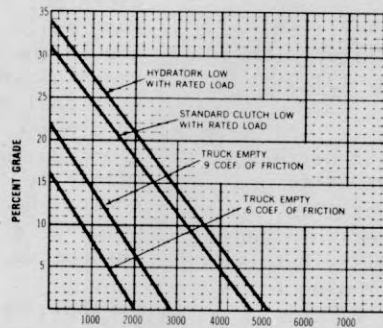

AVAILABLE DRAWBAR PULL IN POUNDS  
WITH TOWING COUPLER 12" FROM FLOOR

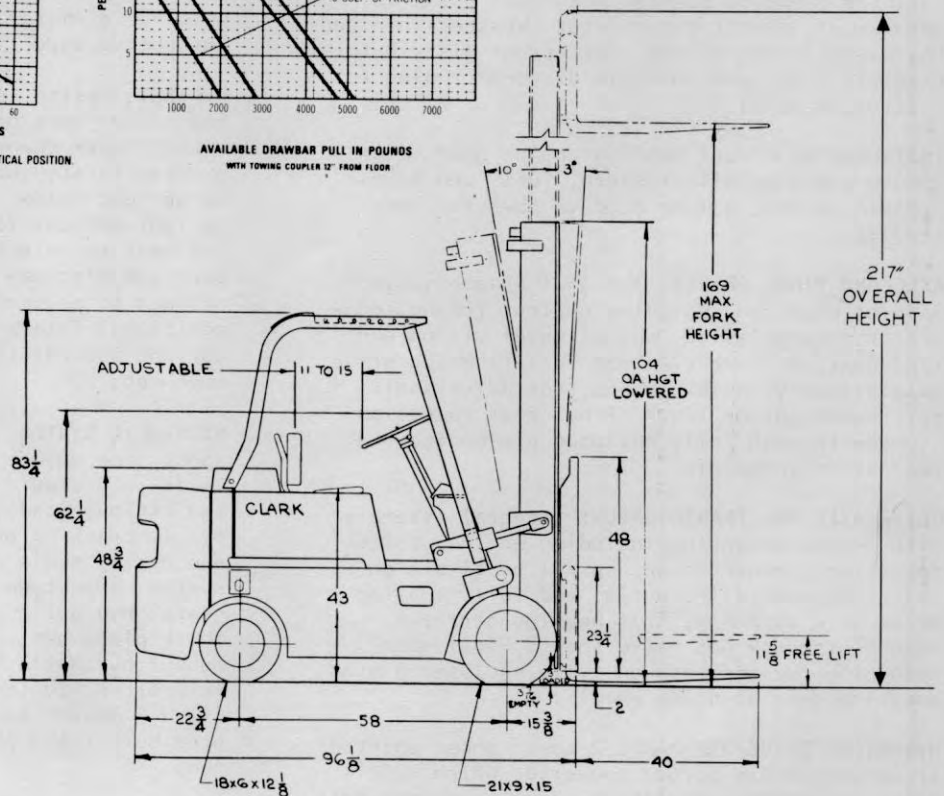



# INDUSTRIAL TRUCK DIVISION



D I M E N S I O N A L

S P E C I F I C A T I O N S

**MODEL:** C60 Weight ..... 10,480 Lbs.

**WEIGHT DISTRIBUTION AND CAPACITY:**

Percent on drive wheels, truck empty:..... 42%  
Rated Capacity...6,000 Lbs. at 24" load center

**ENGINE:** Industrial Continental Red Seal, 6 Cylinder, "L" head, equipped with stellite-faced valves and seats; also positive valve rotators. Connecting rods; main bearings, cam shaft, and timing gears are pressure lubricated by submerged gear-type pump. Mechanical governor controls engine speed accurately without choking off power. Updraft carburetor.

Model.....	F-227
Bore .....	3 5/16"
Stroke.....	4 3/8"
Displacement, Cu. Inches.....	226
Crankcase Capacity, quarts.....	5
Fuel Tank Capacity, gallons.....	12
Governed RPM with no load.....	2400
SAE rated horsepower at 2400 RPM.....	73
Max. SAE rated torque, Lb Foot at 1200 RPM.	176

**ENGINE FILTERS:** Three Types - (1) Fuel filter in metallic bowl. (2) One-quart oil filter with automatic type replaceable cartridge. (3) Oil bath air cleaner.

**ELECTRICAL SYSTEM:** 12-volt, 60-amp-hour battery; 25 amp low cut-in generator charges at idle. Enclosed electric starter motor has positive engagement, electrical cut-out. Weather-shielded keyless starting switch; dust-proof distributor electric horn; and multiple disconnect plug to instrument panel.

**INSTRUMENTS:** Direct reading engine hour meter; ammeter, engine oil pressure, fuel, and temperature gauges, all mounted in cowl for easy reading.

**AXLE AND FINAL DRIVE:** Integral assembly with 3-point mounting including engine, torque converter, transmission, spiral bevel pinion and ring gear, differential and full-floating drive axle assembly. Axle housing, not drive shaft, carries weight of truck. Final gear reduction is made through fully enclosed pinion and ring gear at drive wheels.

**DRIVE AXLE AND TRANSMISSION:** Integral assembly with 3-point mounting including engine, torque converter, transmission, spiral bevel pinion and ring gear, differential and full floating drive axle assembly. Axle housing carries weight of truck not drive shaft. Final gear reduction is made through fully enclosed pinion and ring gear at drive wheels.

**HYDRATORK DRIVE-STANDARD:** 2-speed power shifted transmission has torque converter which multiplies engine torque without shock on drive shaft and gears. Transmission oil is cooled thru

cooler in bottom radiator tank and is a filtered system with replaceable type cartridge. The forward and reverse gears and high and low range gears are in constant mesh. Direction selector lever for left-hand finger-tip control on steering column.

**HYDRAULIC INCHING:** In close quarters the "free pedal" portion of either the left or right foot inching-brake pedal, hydraulically actuates inching valve permitting power to be gradually disengaged from drive wheels, even when engine is running at top speed for fast lifting.

**BRAKES:** (Two system).Hydraulic spot disc brakes provide powerful braking without self-energization. Eliminates sudden "grabbing" of the brakes. Foot brake torque multiplied through final reduction at each drive wheel minimize pedal effort. Brakes are enclosed within drive axle housing and require no adjustment for lift of lining. Mechanical parking brake operates on transmission drive shaft.

**STEERING:** Power steering is standard. Steering control is maintained through mechanical linkage in the event of power failure. Strong vanadium steel steer axle is mounted on two torsional rubber bushings to cushion shock and to provide articulation for ground level variations up to 6" Positive stops for lateral stability. Inclined king pins minimize road shocks. Recirculated ball type steering gear with 18" diameter handwheel. Tie rods are automotive type

**UPRIGHT:** Nested telescopic roller types. "I" beam inner section of SAE 1045 Steel is nested within outer channel of SAE 1045 steel for greater safety and visibility. Side loading on upright rails is taken on upright rollers. Upright and carriage rollers are adjustable for wear to maintain new trucks to lances. Carriage also has 4 adjustable side thrust rollers to prevent binding. Carriage has additional lateral thrust rollers to prevent upright spread, insuring maximum free-rolling movement.

**HYDRAULIC SYSTEM:** Full feathering balanced spool type valves for gentle starts and stops. Built-in pressure relief valve protects system against overloads; will open fully within 100 p.s.i. cracking pressure. SAE straight threads and o-ring seals used throughout pressure system. Vane-type pump is driven by hardened gears. Hydraulic sump, built into frame of 3/8" thick plate has 12.5 gal. capacity. Flexible rubber hydraulic hose lines are steel braid reinforced. System is protected from dirt by (1) a 5 micron pleated replacement filler cap breather, (2) a 25-micron full flow filter in sump.



# INDUSTRIAL TRUCK DIVISION



**FORK CARRIAGE AND FORKS:** All-welded construction, 1045 steel fork carriage to withstand impacts. Lateral fork adjustments from 0" to 40" with or without optional load rack. Convenient snap action latch assures positive fork positioning. Heat treated and upset forged forks to provide full section strength at heel.

**SEATING:** Rubber mounted extra wide seat and back rest are Polyether, covered with vinyl plastic. Curved back rest tilts to provide additional driver comfort. An automatic type latch releases the seat for horizontal adjustment up to 4".

**MAINTENANCE:** Split swing-out hood offers easy access for servicing. Check-points such as water and hydraulic sump filler caps, oil dipstick and filler readily accessible. Battery swings out. Quickly detachable counterweight is hook mounted, secured with one large bolt.

**GENERAL:** Protectoseal gas tank filler cap. 12" height recessed pin-type coupler. Bolts, and screws and zinc or cadmium plated. Multi-pass muffler. All exposed surfaces are shot-blasted and prime painted with weather resistant paint.



INDUSTRIAL TRUCK DIVISION



OPERATORS

MAINTENANCE

PARTS

MANUAL

FOR

CY-60

CLARK EQUIPMENT COMPANY

PUBLISHED BY

TECHNICAL SERVICE DEPARTMENT  
BATTI, CRESA, MICHIAN, U.S.A.



# INDUSTRIAL TRUCK DIVISION



## SPECIFICATIONS

Air Cleaner..... 3/4 pints  
 Cooling System Capacity ..... 15 quarts  
 Fan Belt Deflection (long span)..... 3/4"  
 Brake Pedal Free Travel..... 3/16 to 5/16 inch  
 Torque Converter..... diameter 11 inches  
 ..... Torque multiplication 2 to 1  
 Transmission Hydratork  
 Speeds: 2  
 Capacity: 13 quarts

### STEERING AXLE

Toe in..... 0 degrees  
 Camber..... 1 degree  
 Caster..... degrees  
 Left hand turning radius angle:  
 Left wheel..... 78 degrees  
 Right wheel..... 55° 42'  
 Right hand turning radius angle:  
 Left wheel..... 55° 42'  
 Right wheel..... 78 degrees

### DRIVE AXLE

Ratio-Bevel Gear..... 4.375 to 1  
 Wheel Reduction..... 4.09 to 1  
 Axle end (grease)  
 capacity..... 1 1/4 pounds

### MAIN HYDRAULIC PUMP

Type ..... Vane  
 Capacity..... 17 GPM @ 2250 engine RPM

### STEERING PUMP

Type ..... Vane  
 Capacity.....  
 ..... regulated to 2 GPM by flow control

### HYDRAULIC VALVE

Pressure Relief Valve Setting.....  
 ..... 2000 PSI @ 2250 engine RPM

### ELECTRICAL SYSTEM

Starting Rotor  
 Brush tension (min)..... 35 Oz.  
 Rotation viewing D.E. .... C  
 Spec. No. .... 2441  
 No load test:  
 Volts ..... 10.6  
 Min. Amps ..... 49\*  
 Max. Amps ..... 76\*  
 Min RPM ..... 6200  
 Max. RPM ..... 9400

Resistance test:  
 Volts ..... 4.3  
 Min amps ..... 270  
 Max amps ..... 310

### Distributor

Rotation viewing D. E. .... C  
 Point opening (in)..... 0.21  
 Cam angle (deg)..... 31-34  
 Spec. No. .... 70  
 Centrifugal advance:  
 Start  
 RPM ..... 300  
 Deg ..... 5-2.5  
 Intermediate  
 RPM ..... 400  
 Deg ..... 3-5  
 Intermediate  
 RPM ..... 800  
 Deg ..... 5.5-7-5  
 Maximum  
 RPM ..... 1100  
 Deg ..... 7.5-9.5

### Generator

Rotation..... C  
 Circuit..... A  
 Brush spring tension ..... 28  
 Field Current  
 Amps..... 1.69-1.79  
 Volts ..... 12.0  
 Cold Output  
 Amps..... 25.0  
 Volts..... 14.0  
 RPM ..... 1970

### Voltage regulator

Circuit..... A  
 Polarity ..... N  
 Spec. No. .... 2146  
 Cutout Relay  
 Air gap (in)..... 0.20  
 Point opening ..... 0.20  
 Closing voltage  
 ..... range.... 11.8-13.5  
 Voltage regulator  
 Air gap (in)..... 0.75  
 Volt Setting range.....  
 ....14.2-15.2 at 85 degrees  
 Current regulator  
 Air gap (in)..... 0.75  
 Current setting range.....  
 .... 24.5-29 at 85 degrees

Ignition timing..... 2 degrees BTDC

### SPARK PLUGS

..... Resistor .035

### BATTERY (12 Volt)

20 hr. rate @ 61 amp. hr.  
 300 amp. @ 1.6 min. @ 0 deg F  
 300 amp. @ 10 sec. @ 7.7 volts  
 ..... @ 0 deg F  
 6 cell, 66 plates  
 Group number SAE 25 MD.



# INDUSTRIAL TRUCK DIVISION



## SPECIFICATIONS

### WHEEL NUT TORQUE

Steering wheels.... 275-300 lb. ft.  
 Drive wheels..... 450-500 lb. ft.

\* Includes solenoid.

### ENGINE LIMITS AND CLEARANCE DATA

No. of Cylinders ..... 6  
 Bore & Stroke ..... 3 5/16 X 4 3/8  
 Displacement Cu. In. .... 226  
 Compression Ratio ..... 7.28  
 Max. Oil Pressure ..... 20-30  
 Min. Oil Pressure ..... 7  
 Firing Order ..... 1-5-3-6-2-4  
 Main Brg. - Front..... 2 3.8 x 1 1/16  
 Main Brg. - Int. .... (2) 2 3/8 X 1 5/16  
 Main Brg. - Rear ..... 2 3.8 X 1 23/64  
 Conn. Rod Brg:  
 Dia. & Length ..... 2 1/16 X 1 1/8  
 Oil Capacity  
 Crankcase ..... 5  
 Filter ..... 1/2  
 Total ..... 5 1/2  
 Water Capacity (Given in quarts - add  
 approximately 1 quart for hoses)  
 Engine ..... 6 1/2  
 Radiator ..... 10 1/2  
 Total ..... 17  
 Weight - Bare Engine ..... 555

Valve Clearance  
 Intake (Hot)..... .014  
 Intake (Cold) ..... .012  
 Exhaust (Hot)..... .014  
 Exhaust (Cold)..... .020

Valve Guide:  
 Length..... 2 5/16  
 Outside Diameter..... .6575/.6565  
 Stem Hole Diameter..... .3432/.3422  
 Wear Limits - Max. Dia ..... .3447  
 Distance, Cyl. Block Contact.....  
 ..... Face to Guide..... 1 13/32

Dimensions of Standard Inserts and  
 Counterbores:  
 Outside Dia. of Inserts (A)....1.442-1.441  
 Inside Dia of Counterbore (B)..1.438-1.437  
 Press Fit ..... .003-.005

Valves, Intake  
 Stem Dia. .... .3414/.3406  
 Wear Limits, Min. Dia ..... .3386  
 Seat Angle ..... 30°  
 Stem Clearance Limits..... .0026/.0008  
 Wear Limits-Max. Clearance..... .0046  
 Desired Stem Clearance ..... .0015

Valves, Exhaust  
 Stem Dia ..... .3385/.3357  
 Wear Limits - Min, Dia. .... .3357  
 Seat Angle ..... 45°  
 Stem Clearance-Limits..... .0055/.0037  
 Wear Limits, Max. Clearance..... .0075  
 Desired Stem Clearance ..... .0045

Valve Springs  
 Outside Dia. .... 31/32  
 Length-Valve Closed ..... 45/64  
 Wear Limits-Min. Wgt. .... 42#  
 Length-Valve Open ..... 1 27/64  
 Load-Valve Open ..... 961-104#  
 Wear Limits-Min. Wgt. .... 86#





# INDUSTRIAL TRUCK DIVISION



## SPECIFICATIONS

### ENGINE LIMITS AND CLEARANCE DATA

#### Tappets

O. D. Tappet ..... .9990  
 Bore in Block ..... 1.0000  
 Total Max. Wear Limits ..... .005

#### Camshaft

Brg. Journal Dia. #1 .....1.8725/1.8715  
 #2 .....1.8095/1.8085  
 #3 .....1.7465/1.7457  
 #4 .....1.2475/1.2465

Wear Limits-Min. Dia. (.001 UNDER MIN.....  
 (NEW SHAFT DIAMETER).....

Bushing-Inside Dia. #1 ..... 1.8755/1.8745  
 #2 ..... 1.8125/1.8115  
 #3 ..... 1.7502/1.7495  
 #4 ..... 1.2505/1.2495

Bushing-Clearance Limits ..... .004/.002  
 End Play ..... .009/.005

#### Connecting Rods

Bush. Hose Dia ..... .914/913  
 Brg. Hole Dia. .... .1870/2.1865  
 Brg. Thickness ..... 16/.0613  
 Wear Limits-Min. Thk. .... .0608  
 Dia. - Crank Pin ..... 2.0619/2.0627  
 Wear Limits-Min. Dia. .... 2.0609  
 Clearance Limits ..... .0006/.0022  
 Desired Clearance ..... .0015  
 Wear Limits-Max Clearance ..... .0032  
 Side Play ..... .010/.006  
 Desired Side Play ..... .006

#### Main Bearings

Dia. of Brg. Bore  
 in Block ..... 2.5615-2.5622  
 Brg. Shell Thickness ..... .09250/.0928  
 Wear Limits Min. Thk. .... .0920  
 Dia. of Main Brg. Jr. .... 2.3744/2.3752  
 Wear Limits-Min. Dia ..... 2.3734  
 Clearance Limits..... .0007/.0028  
 Desired Clearance ..... .0015  
 C/S End Play ..... .002/.006

#### Crankshaft Fillet Radii

C/S Fillet Radii - 3/32" + or - 1/64" R on  
 all crankpins and mains except rear.  
 C/S Fillet Radii 1/8" + or - 1/64" R on  
 rear main.

#### Piston Pin

Length ..... 2.868/2.878  
 Diameter ..... .8593/.8591  
 Wear Limits-Min Dia ..... .8588  
 Desired Fit..... Light Push  
 Bush. Hole Dia. - Pin ..... .8597/.8595  
 Wear Limits-Max. Dia ..... .8 07  
 Pin Cl. in Bushing ..... .0006/.0002  
 Desired Pin Fit ..... .0004

#### Pistons

Cylinder Dia. .... 3.3145/3.3125  
 Wear Limits-Cyl. Bore ..... .008  
 Piston Pin Hole Dia. .... .8595/.8595

Ring Groove Width #1 ..... .1290/.1270  
 Max. Wear Limits ..... .1310  
 Ring Groove Width-#2-3..... .1285/.1275  
 Max Wear Limit ..... .1305  
 Ring Groove Width-#4 ..... .2535/.2520  
 Max. Wear Limit ..... .2555  
 Ring Groove Width-#5 ..... None  
 Max. Wear Limit ..... —  
 Piston Fit-Feeler Gauge ..... .003-  
 Lbs. Pull ..... 5-10#

#### Piston Rings

Ring Width-#1 ..... .124/.123  
 Wear Limits-Min. Width ..... .121  
 Ring Width-#2 & #3 ..... .124/.123  
 Wear Limits-Min. Width ..... .121  
 Ring Width-#4 ..... .249/.2485  
 Wear Limits-Min. Width..... .2465  
 Ring Width-#5 ..... None  
 Wear Limits-Min Width ..... —  
 Ring Gap Clearance-#1..... .020/.010  
 Ring Gap Clearance-#2 & 3..... .020/.010  
 Ring Gap Clearance-#4 ..... .015/.055  
 Ring Gap Clearance-#5 ..... None  
 Ring Side Clearance-#1 ..... .004/.0025  
 Ring Side Clearance-#2 & 3 .... .0055/.0035  
 Ring Side Clearance-#4 ..... .005/.003  
 Ring Side Clearance-#5 ..... None



INDUSTRIAL TRUCK DIVISION



OPERATORS

MAINTENANCE

PARTS

MANUAL

FOR

CY-60

CLARK EQUIPMENT COMPANY

PUBLISHED BY

TECHNICAL SERVICE DEPARTMENT  
BATTI, CREB, WICHMAN, U.S.A.



# INDUSTRIAL TRUCK DIVISION



## SPECIFICATIONS

### ENGINE TORQUE SPECIFICATIONS

Engines have many studs, bolts, and cap screws of special material and sizes and it is very important that care be exercised to torque all studs and bolts correctly.

The torque specifications; foot pounds, listed below MUST be followed in order to have the engine conform to the original specifications.

Size - Diameter	5/16"	3/8"	7/16"	1/2"	9/16"	5/8"
Cylinder Heads	-----	35-40	70-85	100-110	130-140	145-155
Manifolds	15-20	25-30	40-50	50-60	50-50	60-70
Gear Covers, Water Pumps, Front and Rear End Plates	15-20	25-30	50-55	80-90	-----	-----
Oil Pans	12-16	12-16	-----	-----	-----	-----



# INDUSTRIAL TRUCK DIVISION



NEW MACHINE 50 HOUR SERVICE AND INSPECTION.

Air Cleaner, Service .....	8H 403
Battery Test and Level Check.....	100H 603
Brake Master Cylinder Level Check.....	100H 303
Brake Pedal, Adjust.....	100H 302
Cooling System, Inspect.....	100H 103
Cylinder Head, Tighten.....	1000H 002
Engine Crankcase, Drain and Refill.....	100H 002
Engine Oil Filter, Change.....	100H 002
Fan Belt, Adjust.....	100H 203
Fuel Pump Strainer, Clean or Replace.....	500H 002
Hand Brake, Adjust.....	1000H 1103
Hydraulic Oil Filter, Change.....	500H 103
Intake and Exhaust Manifold, Tighten.....	500H 403
Lift Chains, Adjust.....	100H 403
Lubricate Machine.....	100H 703
Nuts, Bolts and Capscrews, Tighten.....	500H 403
Power Steering Reservoir Level Check.....	8H 703
Pressure Check Main Hydraulic System.....	1000H 1503
Steering Gear Level Check.....	100H 603
Transmission, Converter and Axle Adapter Level Check.....	100H 002
Transmission, Converter and Axle Adapter Change Filter.....	500H 002

### N O T E

PERFORM THIS SERVICE AND INSPECTION AFTER  
 THE FIRST 50 HOURS OF OPERATION ON NEW  
 MACHINES.



INDUSTRIAL TRUCK DIVISION



OPERATORS

MAINTENANCE

PARTS

MANUAL

FOR

CY-60

CLARK EQUIPMENT COMPANY

PUBLISHED BY

TECHNICAL SERVICE DEPARTMENT  
BATTI, CRESA, MICHIAN, U.S.A.

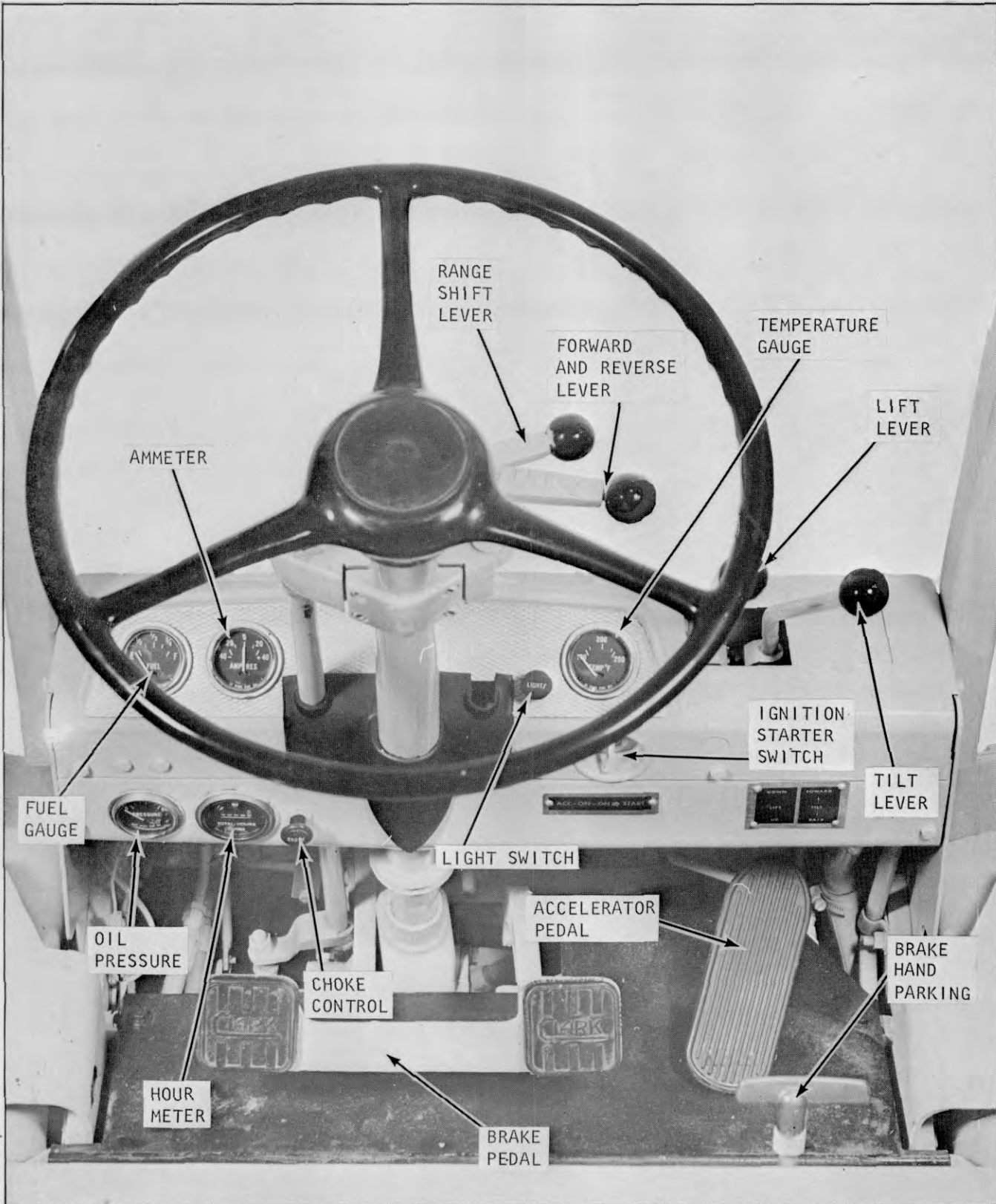

Plate 9478. Overall Controls



Plate 8606. Oil Pressure Indicator

If the oil pressure is erratic or falls below the above limit, stop the engine immediately and find the cause of the trouble. Refer to trouble shooting section for this information. On new machines, after starting machine, run it at idle for five minutes, then stop engine and recheck oil level in crankcase. Bring oil level to high mark, if necessary.

**NOTE**

Before placing machine in operation, run engine a few minutes to warm oil especially in cold operating conditions.

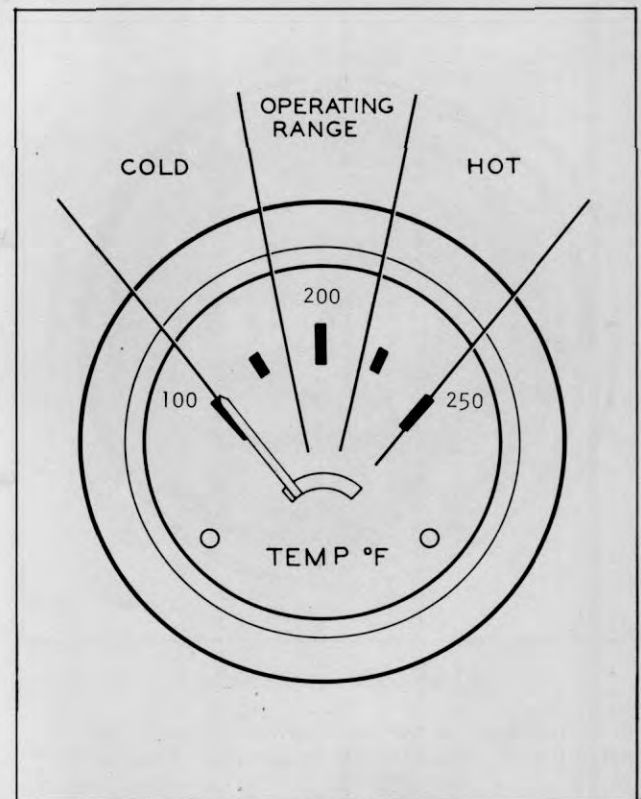

Plate 9479. Engine Coolant Temperature Indicator

**NOTE**

The coolant temperature should register in the operating range after the first few minutes of operation. Low operating temperatures wastes fuel and increases engine wear.

**CAUTION**

DO NOT IDLE THE ENGINE FOR LONG PERIODS AS IT IS NOT ONLY DETRIMENTAL TO THE ENGINE BUT ALSO INCREASES OPERATING COSTS AS YOU ARE USING FUEL WITHOUT BENEFIT.



Plate 7162. Hour Meter

The hour meter accurately records the actual hours of machine operation. This will serve as an aid in determining the time intervals for lubrication and preventive maintenance services.

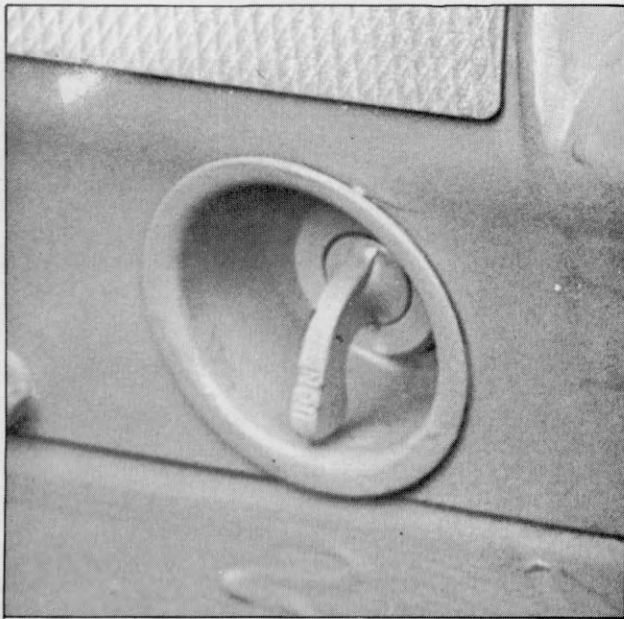

Plate 7018. Ignition Switch





# INDUSTRIAL TRUCK DIVISION



## OPERATIONS

### STARTING

Place all transmission control levers in neutral position. Pull out on choke and engage the starter by actuating the ignition switch in the start position.

#### CAUTION

DO NOT ENGAGE THE STARTER LONGER THAN 15 SECONDS WITHOUT A MINUTE OR SO INTERVAL BETWEEN TRIALS.

If the engine becomes overchoked or flooded; push choke button in, depress accelerator pedal fully and engage starter. If all necessary equipment is in correct working order, the engine will start.

After engine has started, check instrument panel making certain the engine oil pressure indicator shows adequate pressure. If no oil pressure is indicated, stop engine and correct the difficulty.

#### NOTE

RUN ENGINE A FEW MINUTES TO WARM OIL, BEFORE PUTTING MACHINE TO WORK ESPECIALLY IN COLD OPERATING CONDITIONS.

#### TO OPERATE MACHINE

1. Place transmission control levers in neutral position and start engine.
2. Move Hi and Lo range lever for desired speed.
3. Now move forward and reverse lever out of neutral and into position for desired direction. Accelerate as required.
4. Inching Operation: To inch the machine into a load, the brake pedal should be depressed in its free travel range and the accelerator pedal actuated as required. The initial brake movement is used to regulate the inching control valve which allows a decrease in pressure on the transmission selector pack discs. This permits controlled slippage of the discs allowing the machine to inch - - - after the brake pedal travel has actuated the inching valve mechanism the brake become applied and all pressure by-passes the selector discs.

### CAUTION

TO PROLONG MACHINE LIFE IT IS BEST TO COME TO A COMPLETE STOP BEFORE SHIFTING TO THE OPPOSITE DIRECTION.

ALLOW FOOT TO REST ON BRAKE PEDAL ONLY WHEN INCHING IS DESIRED. DO NOT ALLOW FOOT TO REST ON BRAKE PEDAL WHILE DRIVING MACHINE FROM POINT TO POINT. RIDING THE BRAKE PEDAL WILL CAUSE CONTINUED SLIPPAGE OF THE TRANSMISSION SELECTOR PACKS RESULTING IN OVERHEATING AND UNNECESSARY WEAR OR DAMAGE TO TRANSMISSION COMPONENTS.

#### TO STOP MACHINE

Remove foot from accelerator pedal and depress brake pedal. If machine is to be parked, place transmission control levers in neutral position, apply hand brake and shut engine off.

### CAUTION

IF THE ENGINE HAS BEEN OPERATING AT OR NEAR FULL LOAD, IT SHOULD BE ALLOWED TO RUN AT FAST IDLE (600 to 800 R.P.M.) FOR ONE OR TWO MINUTES AFTER LOAD IS REMOVED BEFORE BEING STOPPED. THIS ALLOWS INTERNAL ENGINE TEMPERATURES TO EQUALIZE.



# INDUSTRIAL TRUCK DIVISION



## OPERATIONS

### TO MOVE A LOAD

The forks should be adjusted sideways on fork bars to obtain maximum balance in proportion to width of load. Raise or lower forks to proper level and center the load as nearly as possible on the forks. Tilt upright assembly slightly backward to prevent the load from falling, accelerating engine slightly at the same time. Back away from stack.

Adjust the forks with load so they are close to the floor or ground but high enough to avoid hitting obstructions. The operator should have clear vision ahead when moving in a forward direction. When this is not possible, the operator should drive in reverse and sufficiently turn in his seat to obtain clear vision backward.

When the load is to be deposited, enter the area squarely, especially when placing one load on top of another, in order that all piles will be square and secure. Place load directly over desired area and slowly lower to the floor.

### IMPORTANT

EVERY 8 OPERATING HOURS (OR EVERY SHIFT) ELEVATE UPRIGHT TO THE UPPER LIMIT. THIS WILL PROVIDE LUBRICATION TO THE TOP PORTION OF THE LIFT CYLINDER.

### SAFETY AND OPERATION SUGGESTIONS

The use of industrial powered trucks is subject to certain hazards that cannot be overcome by purely mechanical means. The exercise of intelligence, care and common sense by the truck operator is necessary to eliminate the hazards of overloading, slipping and falling of the load; obstructions in the path of travel, or the use of equipment for a purpose for which it is not intended or designed.

The following are a few suggestions that should be followed in the operation of this machine.

1. Operate machine with forks close to floor, loaded or empty, but high enough to avoid hitting obstructions.
2. If vision is obstructed by the load, operate machine in reverse and sufficiently turn in the seat to obtain clear vision.

3. Avoid sudden stops or starts. When backing, be sure to look for fellow workmen before moving machine.

4. Drive carefully at all times. Exercise caution at cross aisles. Sound horn for safety

5. Be sure loads are safe to move. Have loads properly centered on machine. Refer to the Capacity Chart in Specifications for various load center ratings.

6. An operator should be assigned to a specific machine.

7. The operator should be qualified and drive in accordance with established safety rules.

8. If the machine does not respond immediately, report to designated individual in charge. A minor adjustment now may save a major repair later.

9. Do not allow riders or hitchhikers.

10. Operate the machine at a safe distance behind other vehicles.

11. Do not operate machine with wet or greasy hands.

12. Observe highway traffic laws in the operation of the vehicle in the plant.

13. Drive carefully on wet or slippery floors.

14. Keep feet within running line of truck.

15. Avoid overloading the truck -- this is a safety measure against possible injury to the driver and fellow workmen. Overloading shortens the life of the truck and increases maintenance.

16. Do not operate machine for prolonged periods in an unventilated area. All engines produce poisonous carbon monoxide gas as a by-product of combustion and can be dangerous if allowed to accumulate in a closed area.

17. Be sure the brakes are in proper working condition. Be sure all mechanical and electrical components are working correctly.



# INDUSTRIAL TRUCK DIVISION



## LUBRICATION AND PREVENTIVE MAINTENANCE INDEX

### (8 Hours)

	Time Interval & Number (H=Hours)	Page (0000)
Air cleaner check.....	8H.....	403
Brake Pedal free travel & parking brake check.....	8H.....	303
Engine crankcase check.....	8H.....	002
Engine cooling system check.....	8H.....	103
Hydraulic sump and control levers check.....	8H.....	503
Instrument indicators check.....	8H.....	203
Instrument indicators check.....	8H.....	204
Power steering pump.....	8H.....	703
Tire and rim maintenance.....	8H.....	602
Tire and rim maintenance.....	8H.....	603

### (100 Hours)

Brake pedal free travel check.....	100H.....	302
Brake system check.....	100H.....	303
Battery check.....	100H.....	603
Cooling system check.....	100H.....	103
Converter, Transmission and Axle Adapter.....	100H.....	001
Engine crankcase and oil filter check.....	100H.....	002
Fan and generator drive belt check.....	100H.....	203
Hydraulic sump tank breather.....	100H.....	503
Lifting mechanisms check.....	100H.....	403
Lubrication chart.....	100H.....	703
Steering Gear Check.....	100H.....	603

### (500 Hours)

Axle adapter and transmission drain plugs.....	500H.....	004
Fuel pump filter check.....	500H.....	001
Hydraulic sump tank and filter check.....	500H.....	103
Manifolds check.....	500H.....	403
Steering gear adjust.....	500H.....	202
Steering gear adjust.....	500H.....	203
Steering axle and linkage adjustments.....	500H.....	302
Steering axle and linkage adjustments.....	500H.....	303
Transmission oil filter, screen, and level check.....	500H.....	002

### (1000H)

Axle ends lubrication.....	1000H.....	805
Brake bleeding procedure.....	1000H.....	912
Brake bleeding procedure.....	1000H.....	913
Brake service.....	1000H.....	1003
Battery check.....	1000H.....	1705
Cylinder head, manifolds, crankcase, and valves adjust.....	1000H.....	002
Compression test.....	1000H.....	103
Cooling system inspect and clean.....	1000H.....	1202
Distributor adjustments.....	1000H.....	203

### (1000 Hours)

	Time Interval & Number (H=Hours)	Page (0000)
Distributor adjustments.....	1000H.....	203
Distributor adjustments and timing.....	1000H.....	303
Engine Tune-up.....	1000H.....	001
Governor adjustment.....	1000H.....	503
Governor adjustment.....	1000H.....	504
Generator adjustment.....	1000H.....	703
Generator adjustment.....	1000H.....	704
Hand brake adjustment.....	1000H.....	1103
Hydraulic system check.....	1000H.....	1503
Hydraulic system check.....	1000H.....	1504
Hydraulic system check.....	1000H.....	1505
Hydraulic system check.....	1000H.....	1507
Lift and upright adjustments.....	1000H.....	1803
Lift carriage roller adjust.....	1000H.....	1811
Neutral starting switch.....	1000H.....	1793
Roller adjustments.....	1000H.....	1806
Starting motor.....	1000H.....	603
Starting motor.....	1000H.....	604
Steer wheel bearings Lubrication.....	1000H.....	803
Timing.....	1000H.....	304
Transmission stall and pressure chekcs.....	1000H.....	1703
Transmission stall and pressure checks.....	1000H.....	1705
Upright roller adjustments.....	1000H.....	1807
Upright roller lubrication.....	1000H.....	1815
Valve adjustments.....	1000H.....	002
Vacuum test.....	1000H.....	403

### NOTE

Lubrication and Preventive Maintenance illustrations at the beginning of each time interval section. When performing the 100, 500 or 1000 hour lubrication and preventive maintenance, always include the previous lubrication and preventive maintenance schedules.



INDUSTRIAL TRUCK DIVISION



OPERATORS

MAINTENANCE

PARTS

MANUAL

FOR

CY-60

CLARK EQUIPMENT COMPANY

PUBLISHED BY

TECHNICAL SERVICE DEPARTMENT  
BATTI, CRESA, MICHIAN, U.S.A.



INDUSTRIAL TRUCK DIVISION



OPERATORS

MAINTENANCE

PARTS

MANUAL

FOR

CY-60

CLARK EQUIPMENT COMPANY

PUBLISHED BY

TECHNICAL SERVICE DEPARTMENT  
BATTI, CRESA, MICHIAN, U.S.A.

8 HOURS

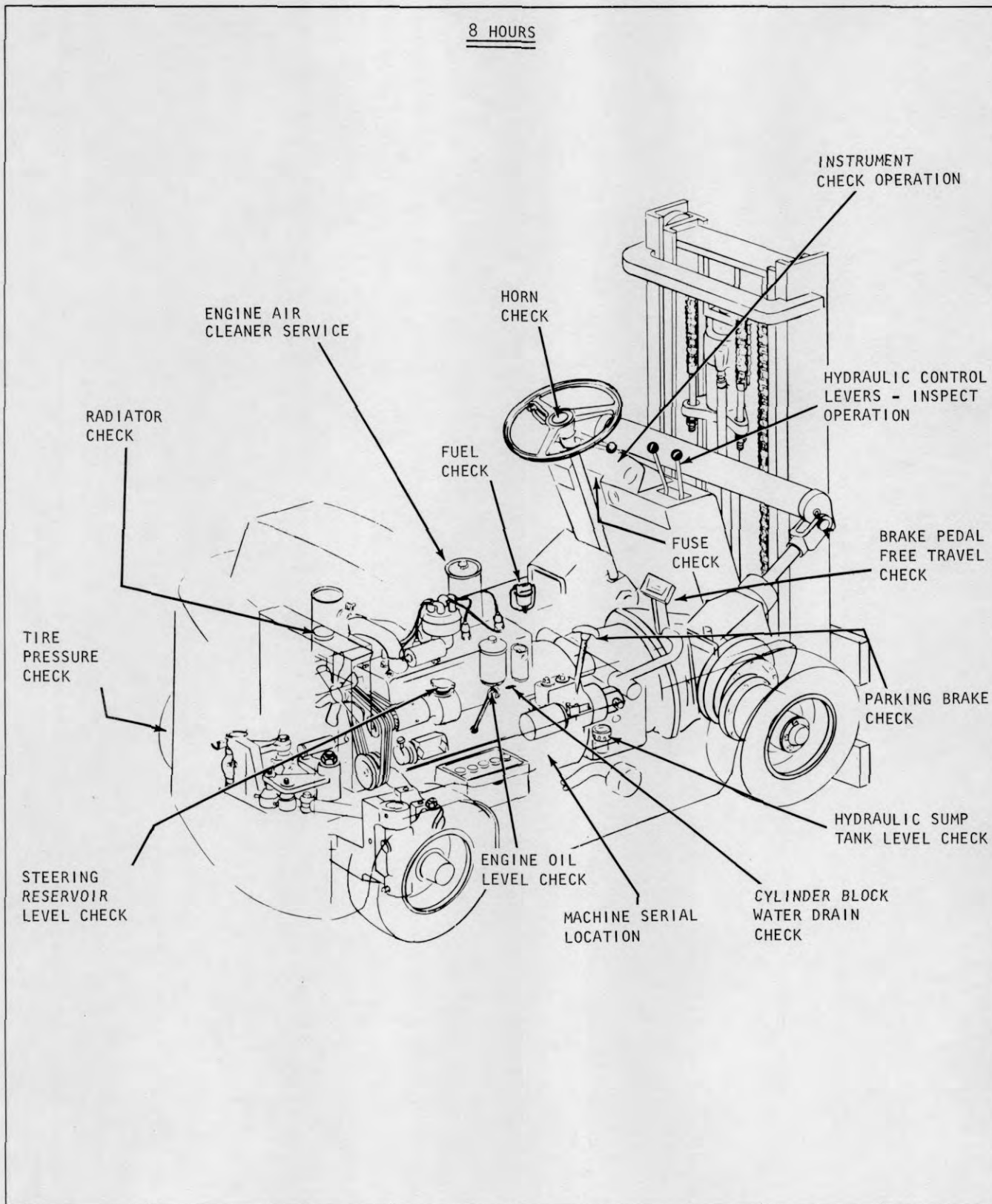

Plate 9480. Lubrication & Preventive Maintenance Illustration

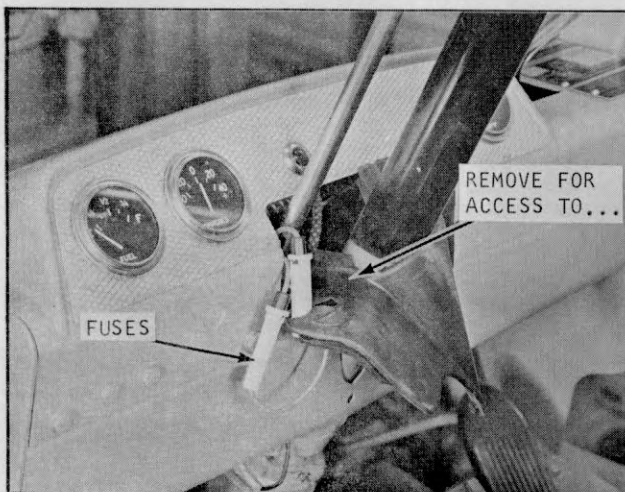

Plate 9473. Electrical System Fuse

**HORN**

Check to be sure the horn is working properly. The horn and ignition fuse is located beneath the dash near the steering column. Fuses are accessible by removing steering column grommet.

**FUEL TANK**

Check fuel supply and fill if necessary. Use a good grade of fuel.

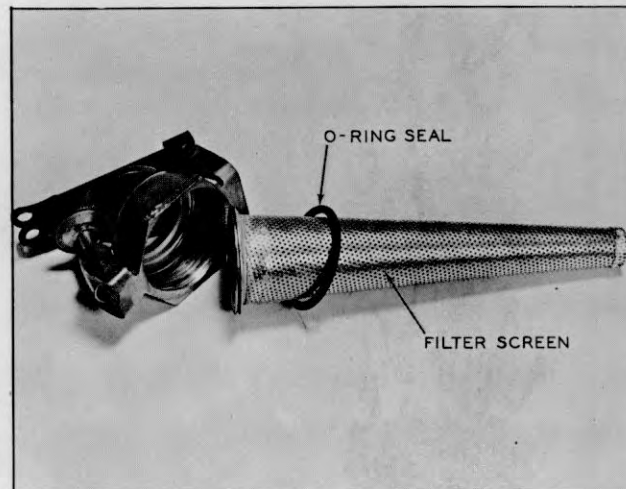

Plate 6627. Fuel Tank Filler Cap & Screen

Before filling fuel tank, make certain the filler cap screen and "O" ring is in place and not damaged.

**C A U T I O N**

DO NOT REMOVE THE SCREEN WHILE FILLING TANK.

```

X X X X X X X X X X X X X X X X X X X X X X X X X X X X X X
X
X           W A R N I N G           X
X
X   CARE SHALL BE TAKEN NOT TO DAMAGE FILLER   X
X
X   CAP SCREEN WITH FILLER HOSE NOZZLE WHILE   X
X
X   FILLING FUEL TANK                       X
X
X X X X X X X X X X X X X X X X X X X X X X X X X X X X X X
    
```

**ENGINE CRANKCASE**

Before attempting to start the engine, first make sure that it has sufficient oil. The oil filler pipe is located on the right side of the machine. The oil level stick is of the dipstick or bayonet type and is also located on the right side of the machine. Fill the crankcase reservoir through the filler pipe to the proper level as indicated on the dipstick.

**C A U T I O N**

NEVER PERMIT THE OIL LEVEL TO FALL BELOW THE 'ADD' MARK ON THE DIPSTICK.

DO NOT OVERFILL THE CRANKCASE, AS TOO MUCH OIL WILL BRING THE LEVEL HIGH ENOUGH FOR THE CONNECTING RODS TO DIP, THUS CAUSING EXCESSIVE QUANTITIES OF OIL TO BE THROWN TO THE CYLINDER WALLS RESULTING IN OIL CONSUMPTION, SMOKING, EXCESSIVE CARBON DEPOSITS AND FOULED SPARK PLUGS.

Crankcase Capacity — Refer to Specifications

		Service "MS" Oils
S.A.E.	10W ....	0° to 32° F.
S.A.E.	20W ....	32° to 75° F.
S.A.E.	30W ....	above 75° F.
or use	10W ....	30 MULTI-GRADE OIL

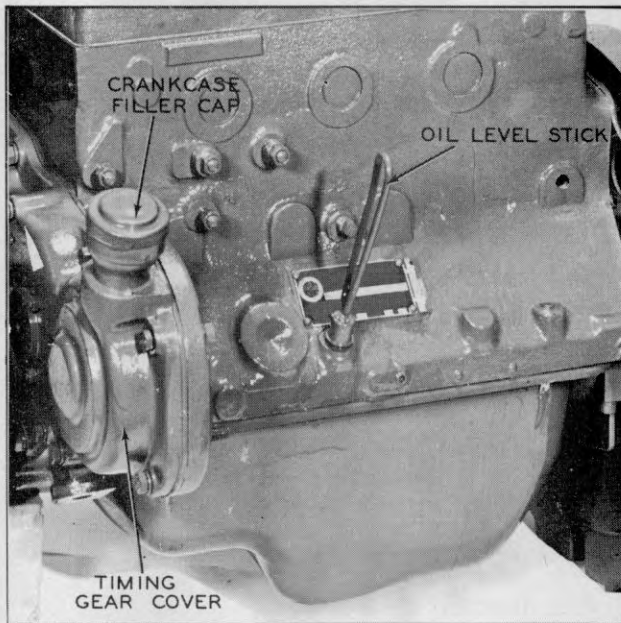

Plate 6629. Engine Crankcase Fill

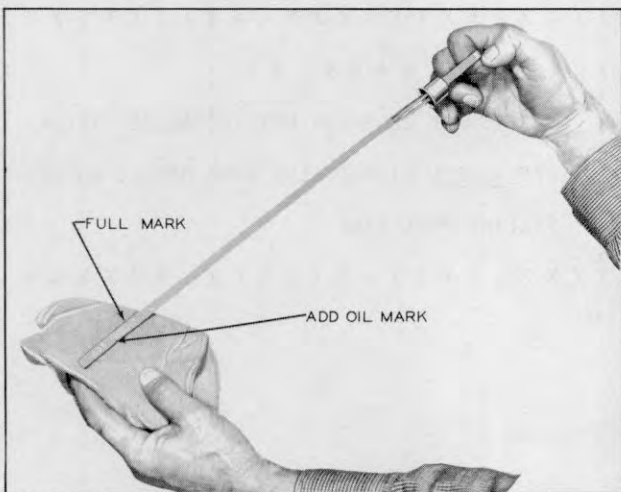

Plate 3145. Crankcase Oil Check



**ENGINE COOLING**

Make sure that the radiator drain cock and the water drain in the cylinder block are closed. Check radiator coolant level and fill to within 1 inch of the top with clean water; or if operation is in cold weather, use a suitable anti-freeze solution.

It is recommended that a soluble oil in the proportion of 1 ounce per gallon of water be added to the Cooling System.

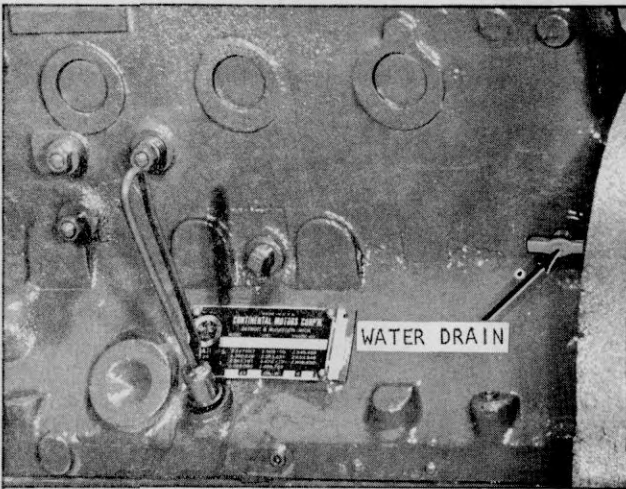

Plate 7008. Typical Cylinder Block Water Drain

**CAUTION**

NEVER POUR COLD WATER OR COLD ANTI-FREEZE INTO THE RADIATOR OF AN OVERHEATED ENGINE. ALLOW THE ENGINE TO COOL AND AVOID THE DANGER OF CRACKING THE CYLINDER HEAD OR BLOCK. KEEP ENGINE RUNNING WHILE ADDING WATER OR ANTI-FREEZE. WHEN PERMANENT ANTI-FREEZE OF THE ETHYLENE GLYCOL TYPE IS USED, THE COOLANT SOLUTION MUST CONTAIN AT LEAST 40% WATER.

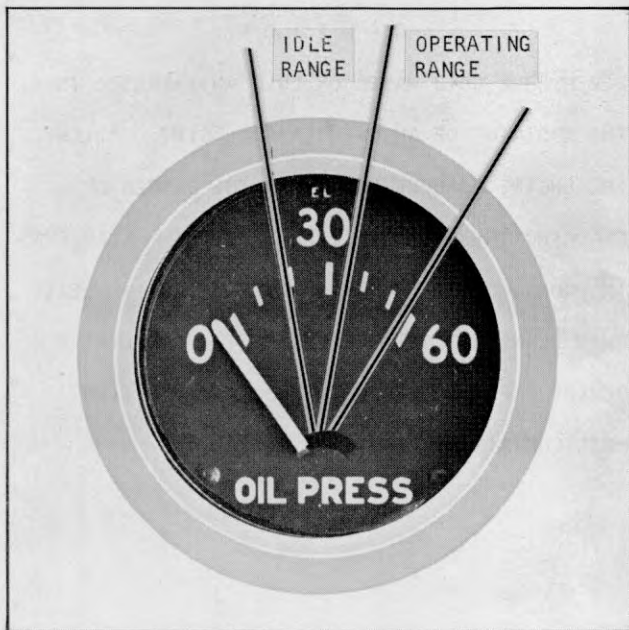

Plate 8606. Oil Pressure Indicator

If the oil pressure is erratic or falls below the above limit, stop the engine immediately and find the cause of the trouble. Refer to trouble shooting section for this information. On new machines, after starting machine, run it at idle for five minutes, then stop engine and recheck oil level in crankcase. Bring oil level to high mark, if necessary.

**N O T E**

Before placing machine in operation, run engine a few minutes to warm oil especially in cold operating conditions.

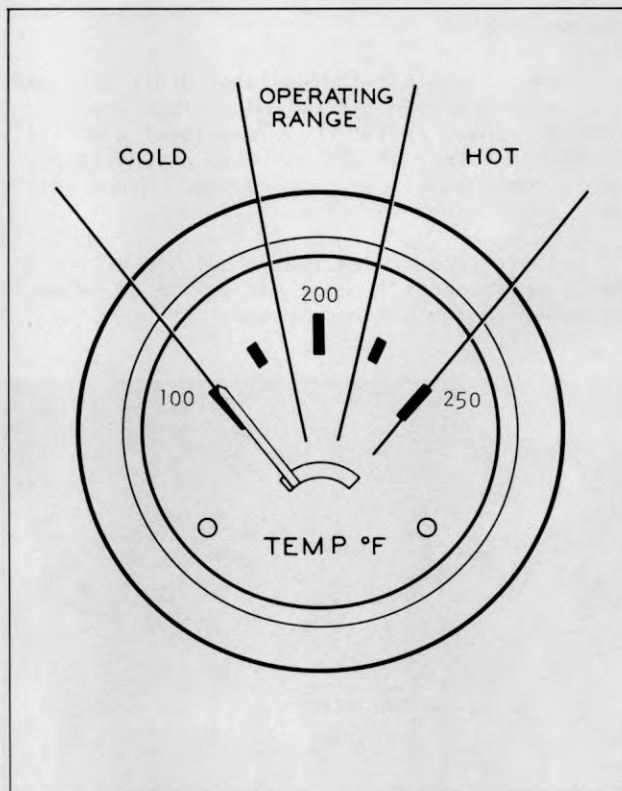

Plate 9479. Engine Coolant Temperature Indicator

**N O T E**

The coolant temperature should register in the operating range after the first few minutes of operation. Low operating temperatures wastes fuel and increases engine wear.

**C A U T I O N**

DO NOT IDLE THE ENGINE FOR LONG PERIODS AS IT IS NOT ONLY DETRIMENTAL TO THE ENGINE BUT ALSO INCREASES OPERATING COSTS AS YOU ARE USING FUEL WITHOUT BENEFIT.



Plate 7162. Hour Meter

The hour meter accurately records the actual hours of machine operation. This will serve as an aid in determining the time intervals for lubrication and preventive maintenance services.

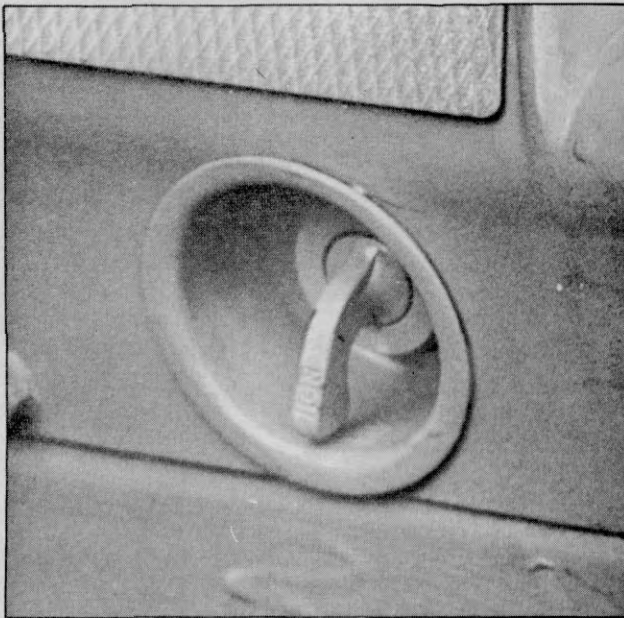

Plate 7018. Ignition Switch

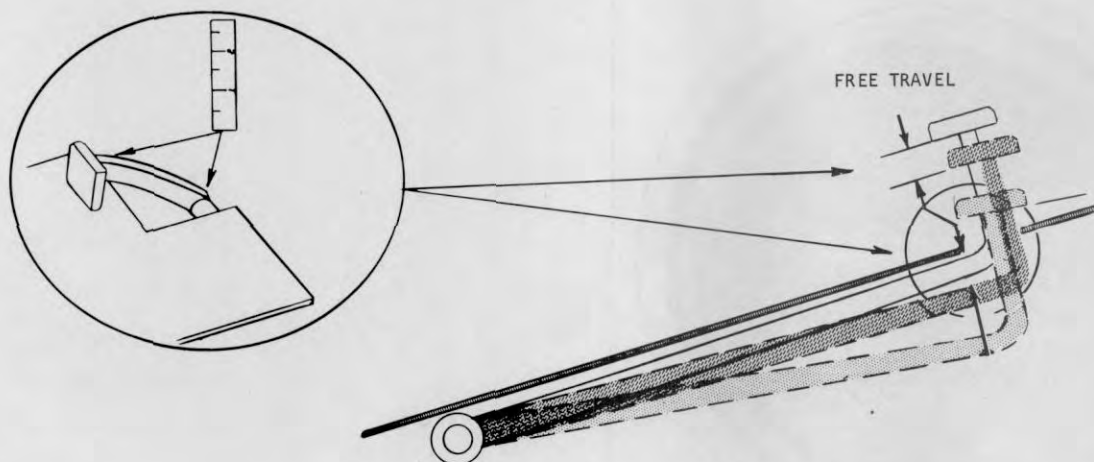

Plate 9592. Brake Pedal Free Travel

**BRAKE PEDAL**

1. Depress brake pedal by hand. When pedal meets resistance from the master cylinder, the distance traveled should be  $3/16''$  to  $5/16''$ . If free travel is incorrect an adjustment should be made at the master cylinder linkage adjuster.

2. Depress foot pedal and hold for at least 10 seconds. Pedal must be solid, must not be spongy or drift under foot pressure

**PARKING BRAKE**

The parking brake linkage should be adjusted so that the brake handle will have 2 inches of upward free travel, before resistance is noticed and the brake becomes applied.

The parking brake must be capable of holding the truck, with full rated load, on a 15% grade. This should be tested while occupying the driver's seat with the parking brake applied and truck out of gear.

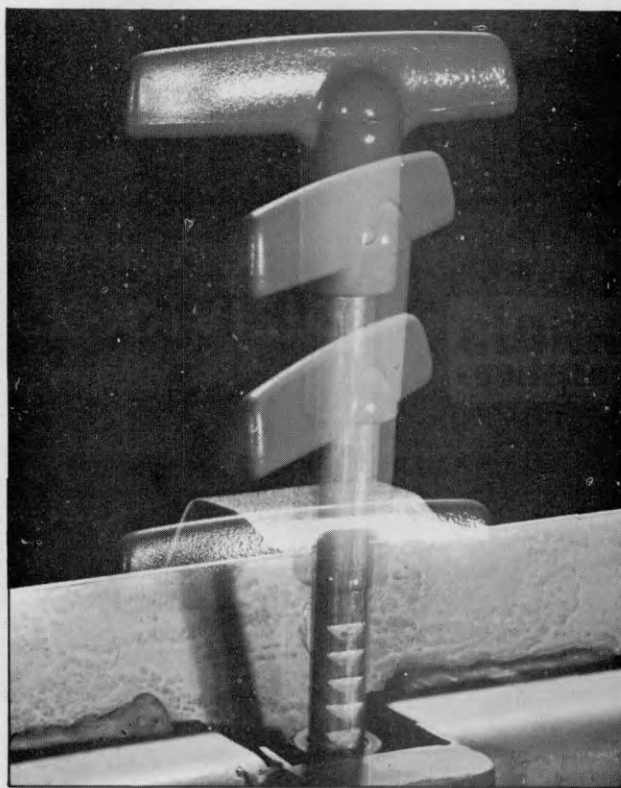

Plate 7482. Parking Brake



Plate 5985. Air Cleaner  
Fill to oil level only.

**AIR CLEANER (OIL BATH TYPE)**

The air cleaner is of the oil bath type. The main function of the air cleaner is to prevent dirt and grit from getting into the engine. All engines, when operating, consume several thousand cubic feet of air per hour. Since dusty air is full of abrasive matter, the engine will soon wear excessively if the air cleaner does not remove the dust before entering the cylinders.

Operating conditions determine the air cleaner service periods. As the dirt is strained from the air flowing through the cleaner, it thickens the oil in the cup and raises the level. If the level is too high, agitation of the oil on the screen is affected and gritty oil is carried over into the air stream, through the carburetor and into the engine cylinders. This would actually introduce a grinding compound with resulting very rapid wear.

Air cleaner maintenance may seem trivial, but it can mean longer engine life, less engine up keep and better economy providing proper maintenance is exercised. Common sense with a close observance can best determine the frequency of air cleaner maintenance.

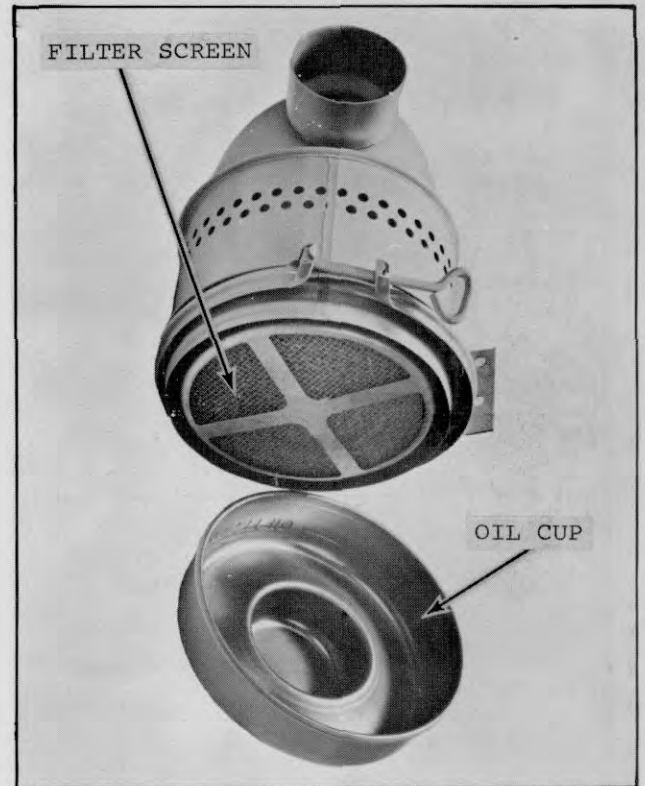

Plate 7663. Air Cleaner Screen and Oil Cup.

**RECOMMENDED MAINTENANCE**

The air cleaner should be checked every 8 operating hours and cleaned if needed. This may be necessary twice daily under extreme dirty conditions.

Remove air cleaner oil cup and wash in a Stoddard type cleaning solvent. Wipe dry and refill with new engine oil. Replace oil cup on air cleaner being sure it is properly positioned.

Check all hose connections to be sure they are tight. Periodically remove hose connections and check interior of hose for dirty or dust. If found, this indicates that additional cleaning intervals are necessary.

**CAUTION**

**ALWAYS CHECK AIR CLEANER ASSEMBLY WITH THE ENGINE TURNED OFF. NEVER CHECK OR REFILL THE OIL CUP WITH THE ENGINE IN OPERATION.**

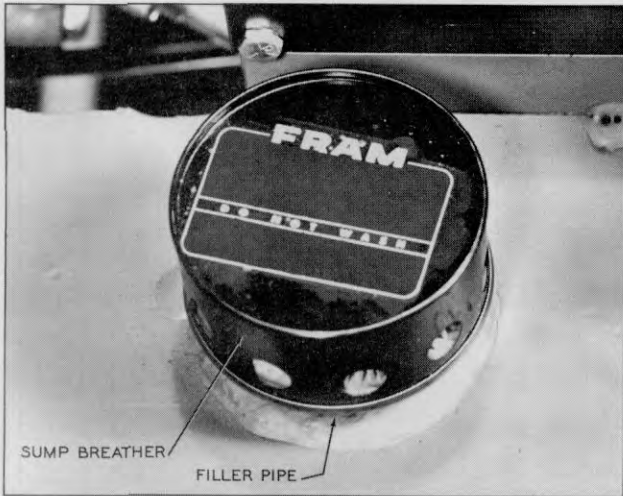

Plate 6626. Hydraulic Sump Tank and Sump Breather

**HYDRAULIC SUMP TANK**

Check hydraulic sump tank fluid level in the following manner:

1. Lower upright.
2. Turn switch key to off position
3. Remove sump breather. Fluid level should be up to bottom of filler pipe.

If necessary, fill sump tank using MS 68 Hydraulic fluid. Move valve control lever with hydraulic pump operating to allow any air in the lines to escape, then recheck sump tank fluid level and fill as required before putting machine in operation.

**HYDRAULIC CONTROL LEVERS**

**I M P O R T A N T**

EVERY 8 OPERATING HOURS (OR EVERY SHIFT)

ELEVATE UPRIGHT TO THE UPPER LIMIT. THIS WILL PROVIDE LUBRICATION TO THE TOP PORTION OF THE LIFT CYLINDER.

Check lift and tilt operation. The lift and tilt cylinders should actuate when lift or tilt levers are moved either way from neutral position.

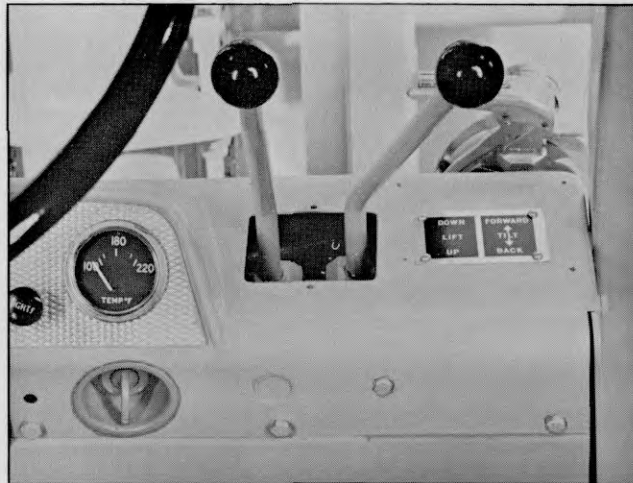

Plate 9535. Lift and Tilt Lever

When load is elevated and control lever returned to neutral position, load should remain in elevated position, with no noticeable downward drift. If load drifts downward excessively, this may indicate lift cylinder U-Cup or seal damage.

With tilt lever in neutral position, upright should remain steady with no noticeable backward or forward drift. If upright drifts excessively either way, this may indicate tilt cylinder seal or U-Cup damage.

**C A U T I O N**

NEVER ALLOW LOADED OR UNLOADED LIFT CARRIAGE TO REMAIN IN AN ELEVATED POSITION FOR ANY PROLONGED PERIODS. LIFT CARRIAGE SHOULD BE LOWERED WHEN NOT IN USE.

DO NOT HOLD CONTROL LEVERS IN EXTREME POSITIONS AFTER A LOAD HAS REACHED ITS LIMITS. TO DO SO WILL RESULT IN HIGH OIL PRESSURE THAT MAY RESULT IN OVERHEATING OF THE HYDRAULIC OIL.

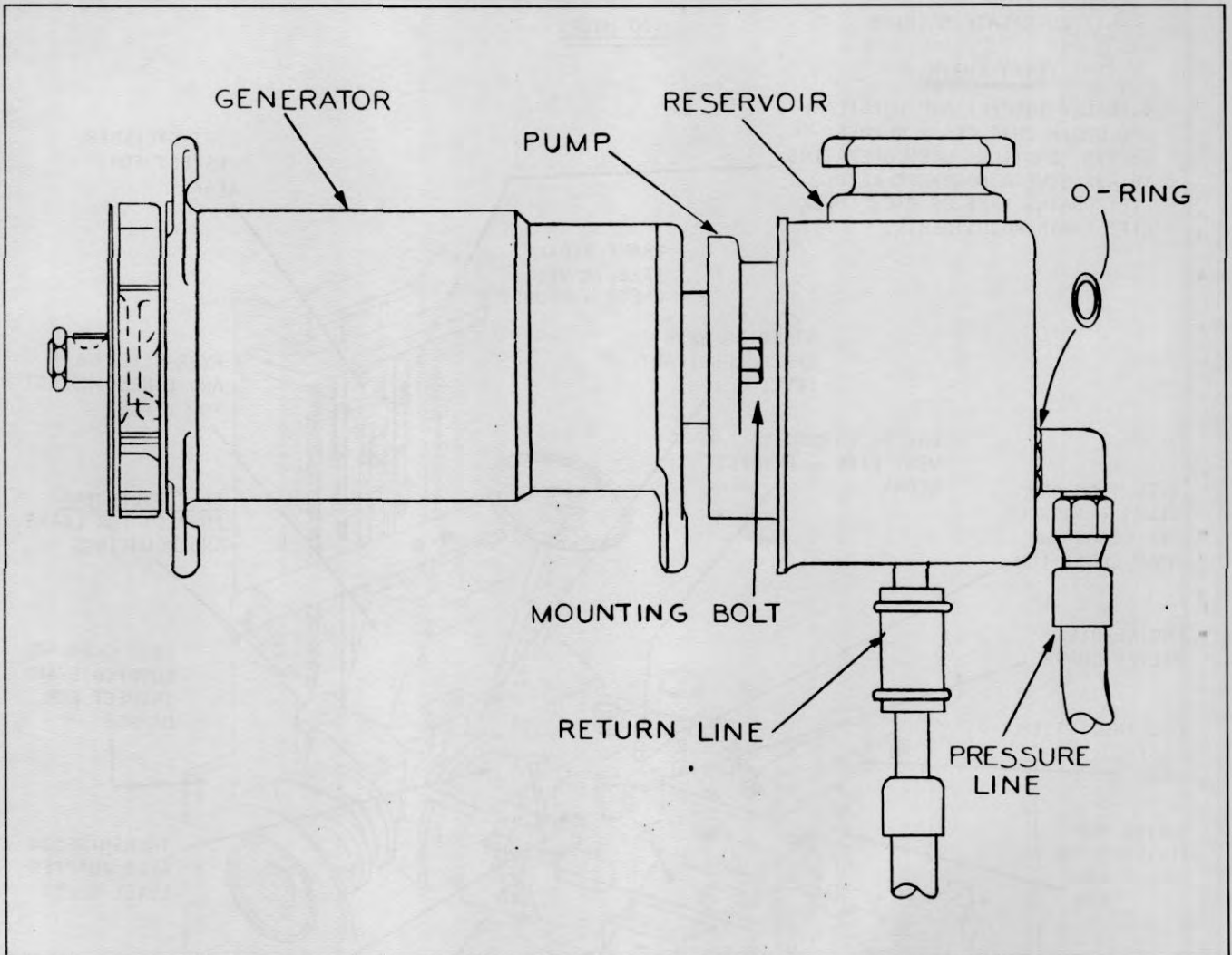

Plate 5940.

Power Steering Pump

**POWER STEERING PUMP**

Check reservoir fluid level each 8 operating hours. Fill (if necessary) with type "A" suffix "A" automatic transmission fluid, CLARK part number 879803. (Fluid containers must display a qualification number prefixed by AQ-ATF.) When fluid in reservoir becomes contaminated it should be drained by removing the return line hose at the bottom of the reservoir. After draining refill to the proper level with the above mentioned fluid. Operate engine for a few minutes and recheck fluid level. Fill to the proper level if necessary.

**CAUTION**

DO NOT OPERATE ENGINE WHILE RESERVOIR IS EMPTY AS THE STEERING PUMP WILL NOT BE LUBRICATED AND SERIOUS DAMAGE WILL OCCUR.

LUBRICATE MACHINE

100 HOURS

LIFT CHAINS

VISUALLY INSPECT AND LUBRICATE  
USE CHAIN LUBE CLARK NUMBER  
886399. CAUTION: WHEN OPERATING  
IN ABRASIVE ATMOSPHERE KEEP  
LIFT CHAINS FREE OF OIL. CHECK  
LIFT CHAIN ADJUSTMENTS.

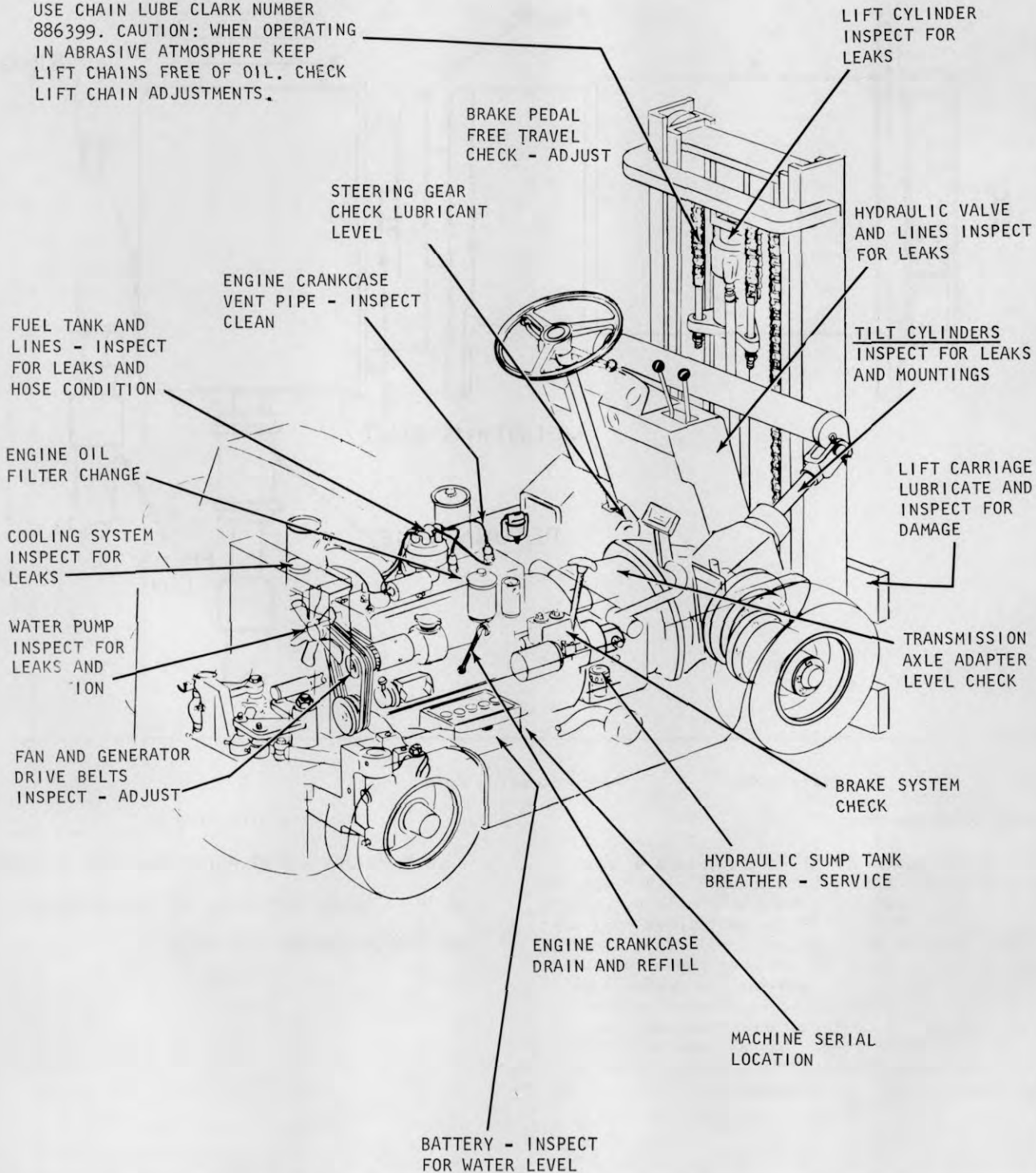

Plate 9481. 100 Hour Lubrication & Preventive Maintenance Illustration Index



### CONVERTER, TRANSMISSION AND AXLE ADAPTER

Verify fluid level with engine operating and transmission in neutral.

Fill with Transmission Fluid Type "A" Suffix "A" that are in cans that have AQ-ATF on them, through the combination filler and dipstick opening. Fill to "Hot Full" mark on dipstick if transmission fluid is at normal operating temperatures. Fill to "Cold Full" mark when oil is at a lower temperature.

FUEL LINES. Make certain that fuel line connections are secure. Check fuel lines for obstructions and leaks. Check screen in fuel filler cap to make certain that it is properly installed.

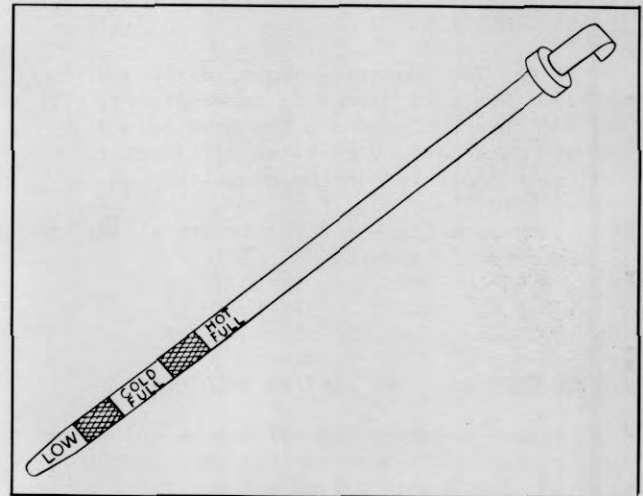

Plate 7303. Transmission Dipstick

```

x x x x x x x x x x x x x x x x x x x x x x x x x x x x x
x                                     x
x           W A R N I N G           x
x                                     x
x   THE FUEL TANK IS AN INTEGRAL PART OF   x
x                                     x
x   THE MACHINE FRAME AND ANY WELDING IN   x
x                                     x
x   THIS AREA SHALL NOT BE ATTEMPTED BEFORE x
x                                     x
x   FIRST TAKING ADEQUATE SAFETY PRECAUTIONS x
x                                     x
x   REPORT TO DESIGNATED PERSON IN AUTHOR- x
x                                     x
x   ITY                                   x
x x x x x x x x x x x x x x x x x x x x x x x

```

**ENGINE CRANKCASE**

Every 100 operating hours, drain and refill. (Drain at operating temperatures). Refill, then run engine a few minutes and add oil as necessary to bring oil level to full mark indicated on the dipstick.

Crankcase Capacity — Refer to Specifications

	Service "MS" Oils
S.A.E. 10W	..... 0° to 32° F.
S.A.E. 20W	.... 32° to 75° F.
S.A.E. 30W	.... above 75° F.

**ENGINE CRANKCASE VENTILATION BREATHER**

Remove breather and oil cup by releasing spring clips. Dislodge foreign particles by washing in a Stoddard type solvent until clean. Allow to air dry. Fill oil cup to level mark with oil of same viscosity as used in engine. Replace breather after it is completely air dried.

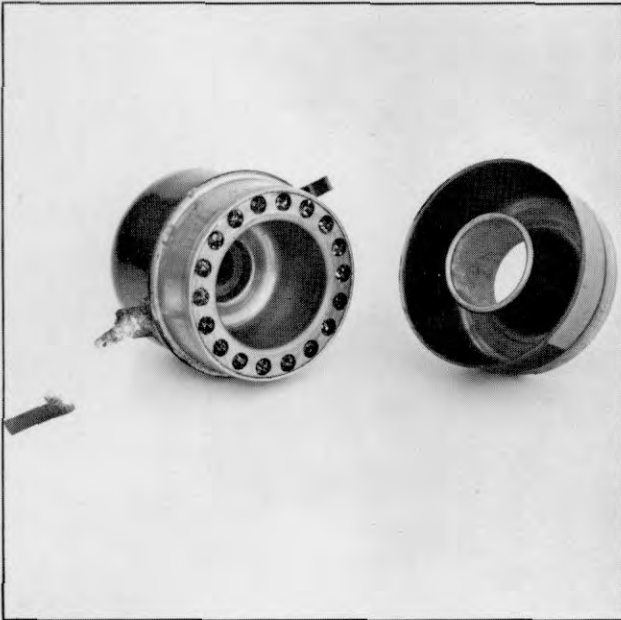

Plate 7033. Engine Breather

**ENGINE OIL FILTER**

The oil filter element is of the replaceable type. The element should be changed whenever the crankcase is drained. To remove the element, remove oil filter cover screw and gasket, oil filter cover, cover spring and cover gasket. Lift out oil filter element. Install new element after draining and thoroughly cleaning filter case. Install new gaskets and replace cover spring, oil filter cover and secure with oil filter cover screw.

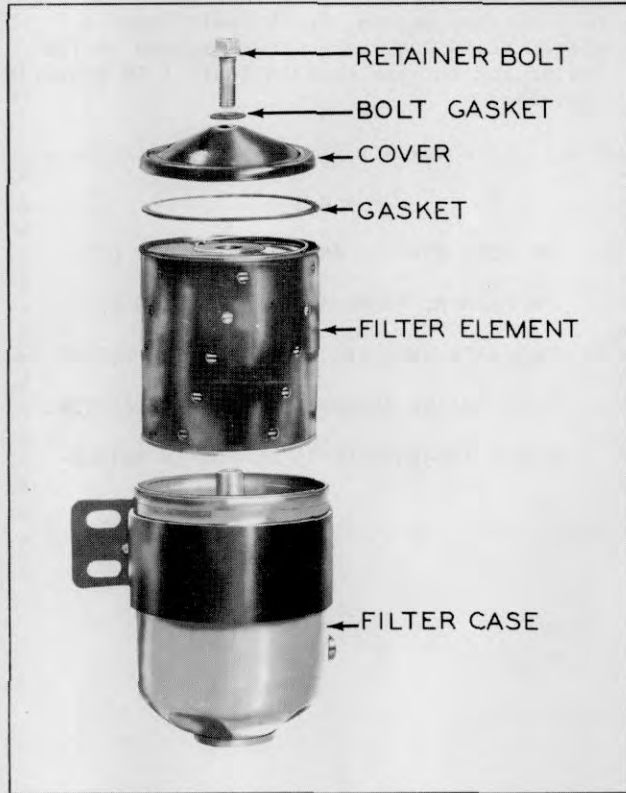

Plate 6332. Engine Oil Filter

**CAUTION**

START ENGINE, RUN AT IDLE FOR A FEW MINUTES, CHECK COVER AND COVER SCREW FOR LEAKS.



Plste 6458. Radiator Pressure Cap

```
x x x x x x x x x x x x x x x x x x x x x x x x x
x
x           W A R N I N G           x
x                                     x
x USE EXTREME CARE IN REMOVING THE RADIATOR x
x                                     x
x PRESSURE CAP. IN PRESSURE SYSTEM, THE x
x                                     x
x SUDDEN RELEASE OF PRESSURE CAN CAUSE A x
x                                     x
x STEAM FLASH AND THE FLASH, OR THE LOOSENED x
x                                     x
x CAP CAN CAUSE SERIOUS PERSONAL INJURY. x
x                                     x
x LOOSEN CAP SLOWLY AND ALLOW STEAM TO x
x                                     x
x ESCAPE. THIS MACHINE IS EQUIPPED WITH x
x                                     x
x A 7 LB. PRESSURE CAP. x
x x x x x x x x x x x x x x x x x x x x x x x x x
```

**COOLING SYSTEM**

Check radiator, hoses and water pump for leaks.

Add proper amount of water or antifreeze solution to cooling system. If antifreeze is not available and machine is to be at rest for an appreciable length of time; drain system when temperature is likely to be 32° F, or lower. If water is added to radiator containing antifreeze solution, always test solution in radiator with a hydrometer to determine the degree of protection. For proper amount of antifreeze solution required to protect the cooling system, refer to instructions on antifreeze container.

**N O T E**

COOLING SYSTEM CAPACITY - REFER TO SPECIFICATIONS.

Accumulated foreign material should be blown from radiator fins with compressed air. Direct air stream through radiator fins towards engine to make this process effective.

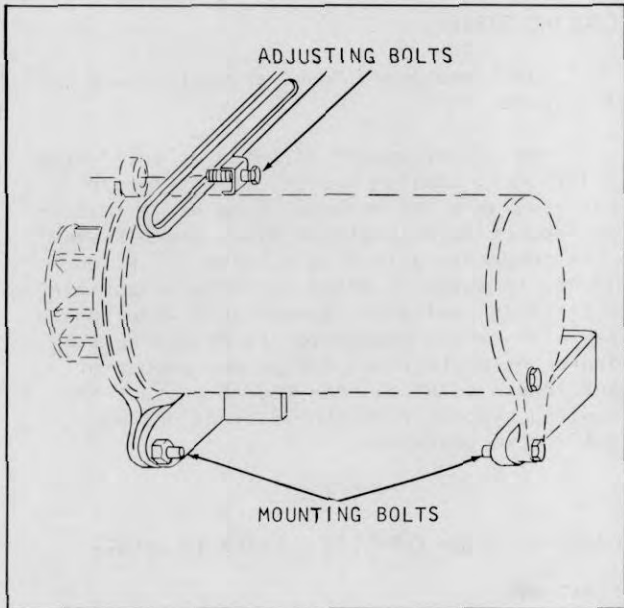

Plate 6631. Generator Drive Belt Adjustment

FAN AND GENERATOR DRIVE BELTS

The drive belts should have finger pressure deflection of 3/4 to 1 inch midway on long span. If belts require adjustment, use following procedure.

1. Loosen generator brace adjusting bolt and two lower mounting bolts, See Plate 6631.
2. Move generator toward cylinder block to . . . Generator Drive Belts and away from . . . cylinder block to tighten belts. Tighten bolts when correct finger deflection is obtained.

**C A U T I O N**

EXERCISE CAUTION WHEN ADJUSTING BELTS. BELTS ADJUSTED TOO TIGHT WILL VERY LIKELY CAUSE

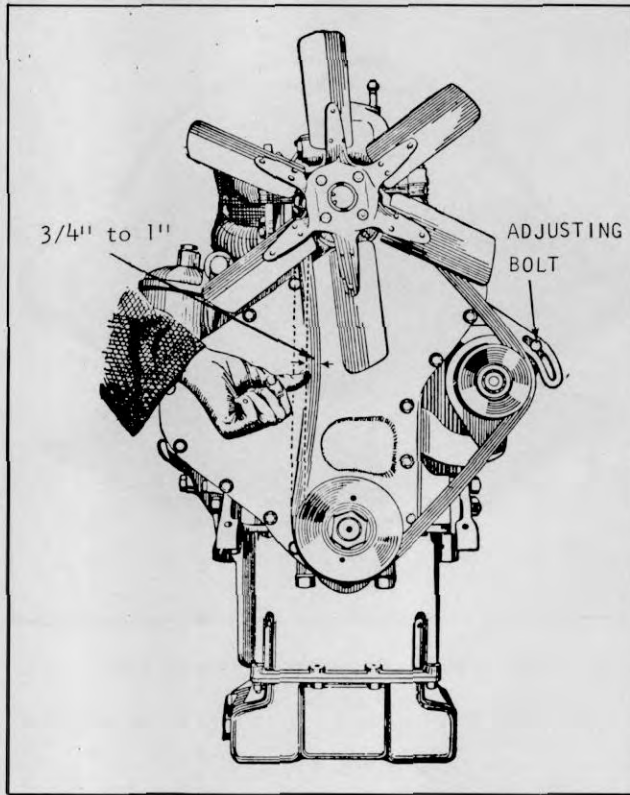

Plate 6632. Belt Deflection Check

BEARING DAMAGE. CONVERSELY, BELTS ADJUSTED TOO LOOSE WILL RESULT IN BELT WEAR AND HIGH ENGINE TEMPERATURE DUE TO BELT SLIPPAGE.

**N O T E**

UPON REPLACEMENT OF DRIVE BELTS, IT WILL BE NECESSARY TO USE A MATCHED SET OF BELTS.

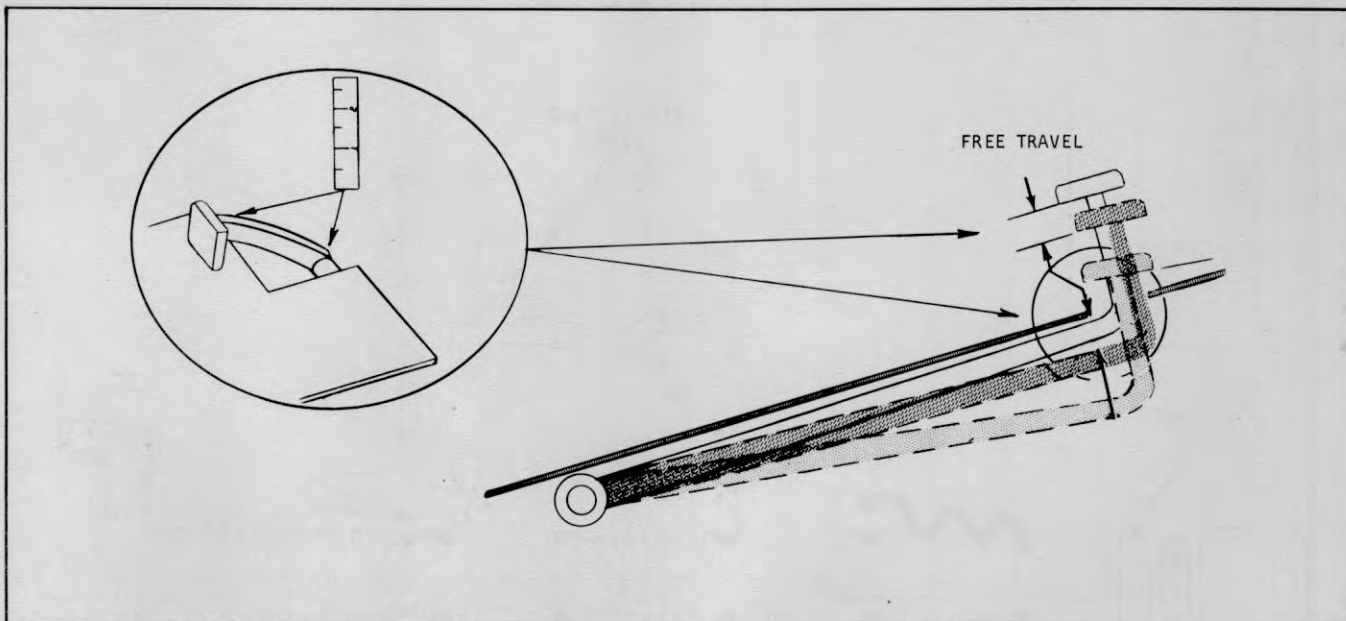

Plate 9592. Brake Pedal Free Travel

**BRAKE PEDAL**

1. Depress brake pedal by hand. When pedal meets resistance from the master cylinder, the distance traveled should be 3/16" to 5/16". If free travel is incorrect an adjustment should be made at the master cylinder linkage adjuster.

2. Depress foot pedal and hold for at least 10 seconds. Pedal must be solid, must not be spongy or drift under foot pressure.

**BRAKE SYSTEM**

Check brake fluid level in the master cylinder. Brake fluid should be within 1/4 inch of the top. Fill with SAE 70 R3 Heavy Duty Brake Fluid. Clark Part Number 1800200.

Master Cylinder Filler Cap Vent Hole:  
Check cap vent hole for obstruction. Vent hole must be open at all times. Clean if necessary, see Plate 6987.

Brake Pedal Adjustment

1. Loosen locknut, See plate 6987.
2. Rotate adjuster in the direction necessary to obtain specified free travel.
3. Tighten locknut to secure adjustment.

**ACTUATION STROKE**

If nearly full pedal travel is necessary to apply the brakes, there is an indication of either lack of fluid in the master cylinder; air in system, leakage at the cylinders, or the brake linings require adjustment or replacement.

**W A R N I N G**

**CORRECT BRAKE PEDAL FREE TRAVEL IS IMPORTANT FOR SAFE OPERATING BRAKES.**

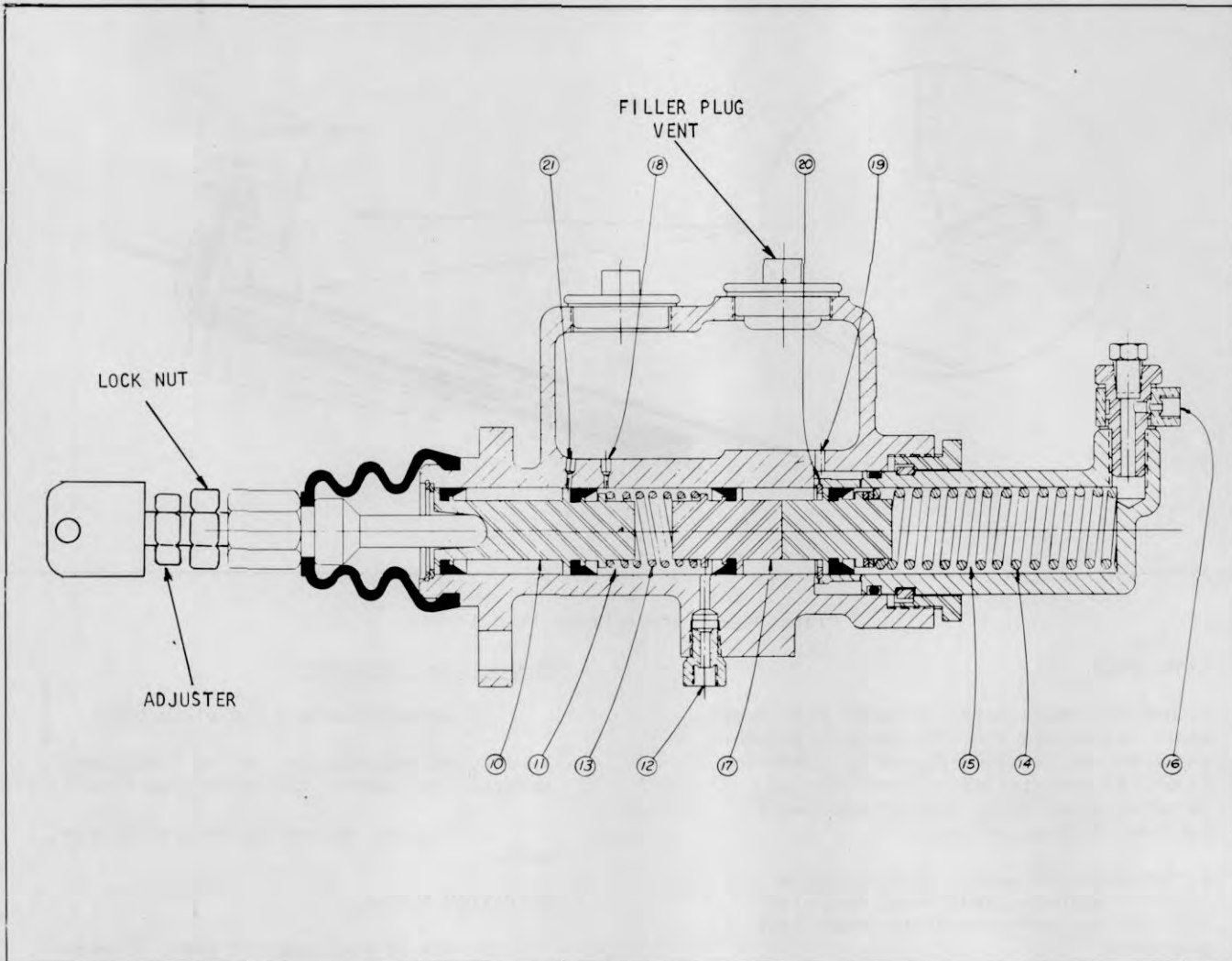

Plate 6987. Master Cylinder

The piston (10) is moved in conventional manner by linkage from the brake pedal. As this is done, oil from the cavity (11) is moved out thru port (12) to the inching control. Since spring (13) is lighter and more readily compressed than spring (14) the oil from cavity (11) will flow thru port (12) more readily and in greater volume than oil from cavity (15) thru port (16) the latter supplying the brake system.

As further motion is imparted to piston (10) from the brake pedal the pressure in (11) builds up to the pressure required for positive brake application. At this time piston (17) is caused to move further into cavity (15) thus forcing high pressure oil out of port (16) and into the brake system.

Thus it is seen that this unit provides initially, low pressure oil to actuate the inching mechanism and to partially actuate the brake mechanism, making brakes ready for immediate application, and finally, high pressure oil for complete brake actuation. In the reverse operation when brake pedal effort is released, the braking effort is removed first, and the inching effort second upon return of the brake to its normal position.

Hydraulic oil is provided to the system thru ports (18) and (19) from a conventional reservoir. Port (20) serves to vent any build up of oil pressure between the two sections of the piston (17). Port (21) serves to vent any build up of oil pressure between the two seals on piston (10).

LUBRICATION AND PREVENTIVE MAINTENANCE

LIFT AND TILT CYLINDERS

Check for drift, leakage at packings, damage and security of mountings (Anchor Pivot Pins, Flanges and Mounting Rings).

LIFT CHAINS

The lift chains are mounted to the chain anchors on the lift carriage and at the chain anchor rods near the lift cylinder piston head.

If it becomes necessary to adjust the lift chains place a capacity load on forks (or device if used) and adjust chains so center line of lower carriage roller is at least 1/2" above the bottom end of the innerslide channel. It is important that the chain adjustment be made with a capacity load. In this manner you will allow for chain stretch.

W A R N I N G

KEEP CLEAR OF LOAD DURING ADJUSTMENT TO AVOID INJURY IF ANY MALFUNCTION SHOULD OCCUR AND CAUSE LOAD TO FALL.

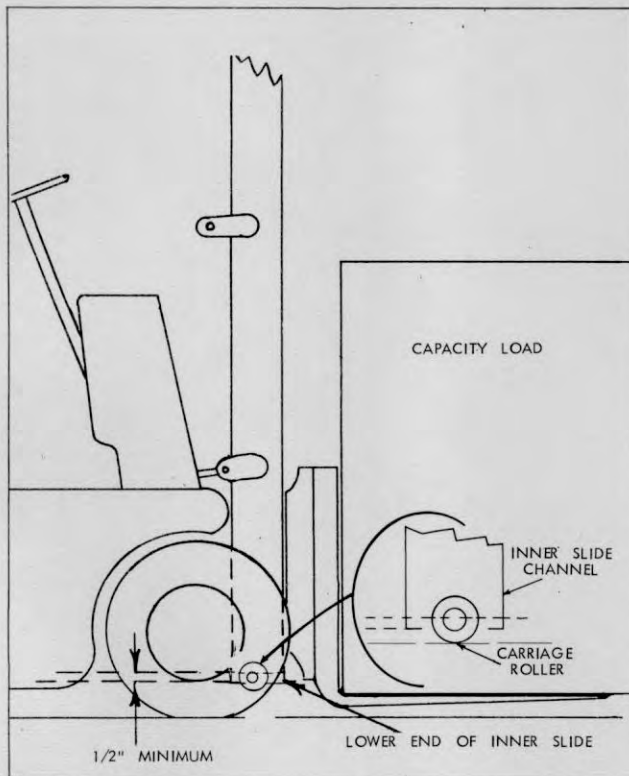

Plate 6884. Lift Chain Adjustment  
(Place Maximum Load On Forks)

LUBRICATE MACHINE

C A U T I O N

WHEN LUBRICATING THE TRUCK, MAKE A VISUAL INSPECTION OF ALL HYDRAULIC LINES, FITTINGS AND ALL ELECTRICAL WIRING. LUBRICATE ALL MISCELLANEOUS LINKAGE WITH S.A.E. NUMBER 20 OIL.

HYDRAULIC CONTROL VALVE AND LINES

Inspect for damage, leakage and security of mounting.

LIFT BRACKET

Inspect for damage, bent forks etc.

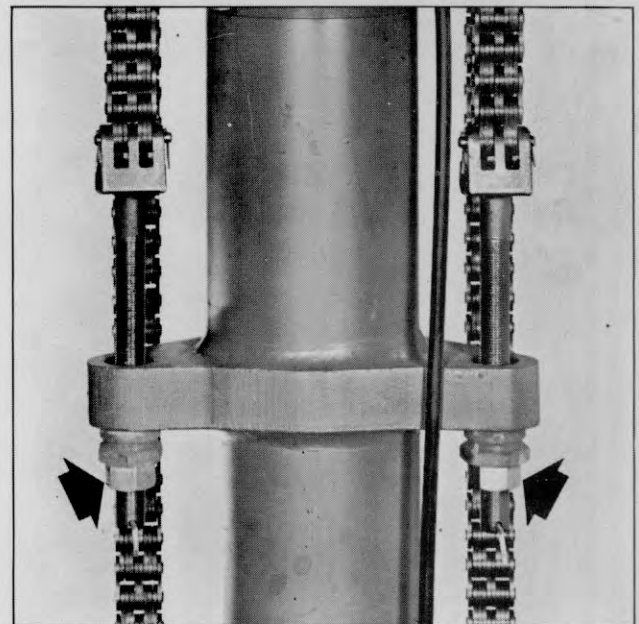

Plate 6634. Lift Chain Adjustment  
(Chain Anchor Rods)

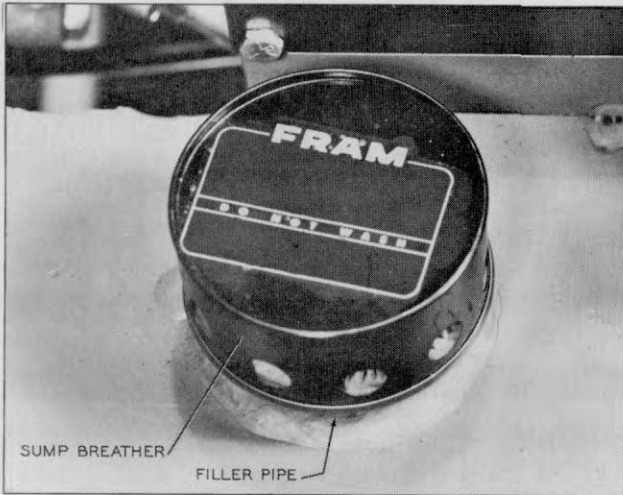

Plate 6626. Hydraulic Sump Tank

### HYDRAULIC SUMP TANK BREATHER

Check breather to be sure it is not dirty or clogged with foreign matter. Replace breather if dirty.

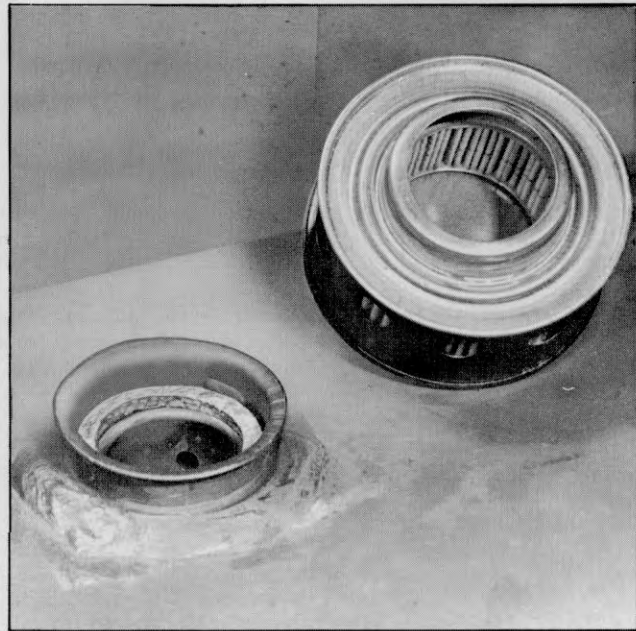

Plate 6682. Hydraulic Sump Tank & Sump Breather



**STEERING GEAR**

Verify lubricant level, fill if necessary with AMOCO Lithium Multipurpose Grease or its equivalent.

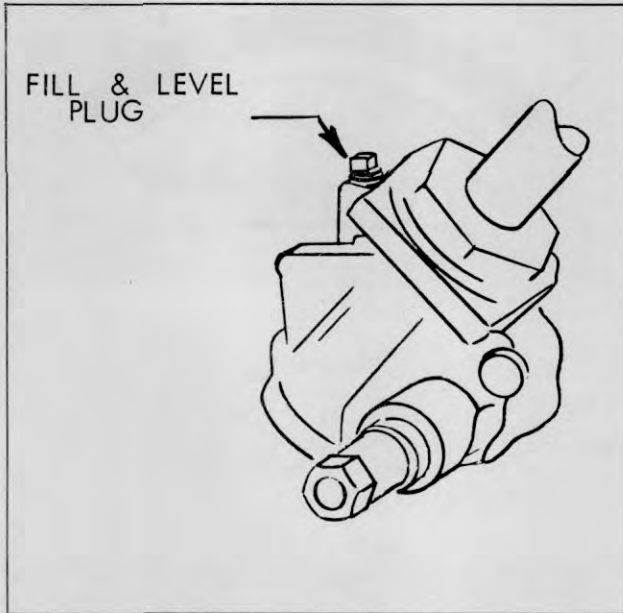

Plate 6429. Steering Gear

**BATTERY INSPECTION**

Remove all caps and check fluid level. Keep the fluid in each battery cell above the plates or up to the level ring in the bottom of the filler well. Use only pure distilled water. If the machine is exposed to freezing temperatures, operate the engine for a period of time to make sure the added water mixes thoroughly with the battery electrolyte solution. Otherwise, the water may freeze and damage the battery.

```

x x x x x x x x x x x x x x x x x x x x x x x x x x x x x
x                                                                 x
x           W A R N I N G                                         x
x                                                                 x
x  NEVER ALLOW FLAME OR SPARKS NEAR THE                          x
x                                                                 x
x  BATTERY FILLER HOLES BECAUSE EXPLOSIVE                          x
x                                                                 x
x  HYDROGEN GAS MAY BE PRESENT                                     x
x                                                                 x
x x x x x x x x x x x x x x x x x x x x x x x x x x x x x
    
```

Take hydrometer reading of electrolyte to determine state of charge. Charge battery if reading is below 1.225 at 24° C (75° F), or below 1.265, if machine is exposed to freezing temperatures. If machine is operating in tropical areas in which freezing weather is

not encountered, the full charge specific gravity reading may be lowered from 1.375 to 1.225 by diluting the electrolyte with distilled water.

**N O T E**

Add distilled water before charging. Do not add distilled water immediately after a charge.

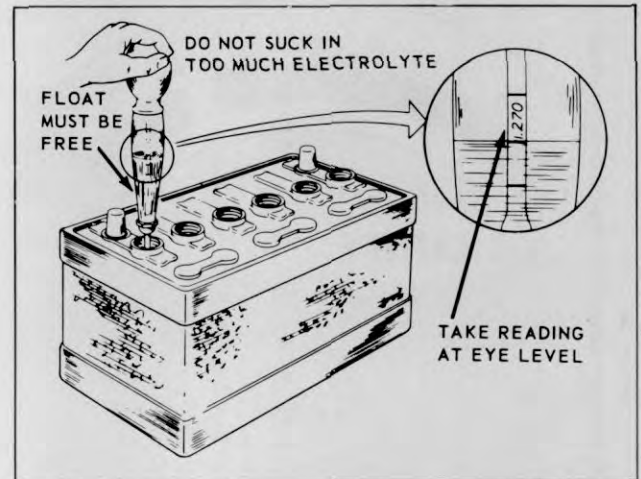

Plate 6271. Checking Specific Gravity of Battery

Make sure that all connections are tight at battery, starter, generator voltage regulator, distributor and spark plugs. Corrosion can be removed from the battery cables and terminals with a solution of baking soda or ammonia and water. After cleaning, flush the top of the battery with clean water, and coat the parts with grease to retard further corrosion.

**BATTERY TEST PROCEDURE**

A defective battery or a discharged battery may be found by performing the following "Light Load Test"

1. Place an electrical load on the battery by cranking the engine for three seconds. If it starts, turn the ignition off immediately.

2. Place a 10 ampere load across the battery terminals for one minute. This will condition the battery so an accurate voltage comparison test can be made between cells. (Turning two headlights on low beam will equal the 10 ampere load - this method may be used in place of the load placed across the terminals)

3. After one minute, and with the 10 ampere load still on the battery, check the individual cells with an expanded scale voltmeter.

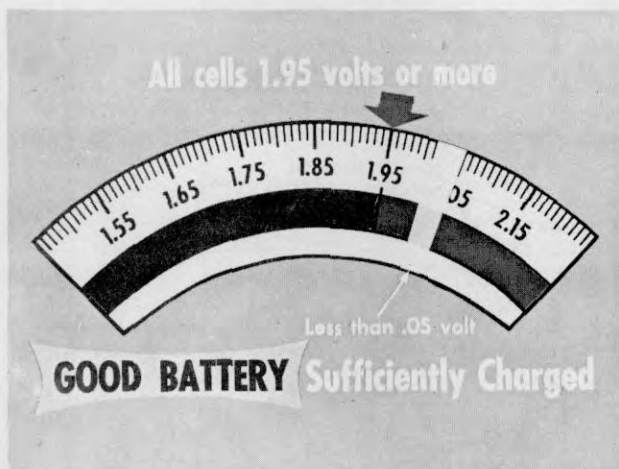

Plate 8306.

4. Place the positive voltmeter prod on the positive side of the cell and the other prod on the negative side. A good battery, sufficiently charged will read 1.95 volts or more on each cell with a difference of less than .05 volt between highest and lowest cell.

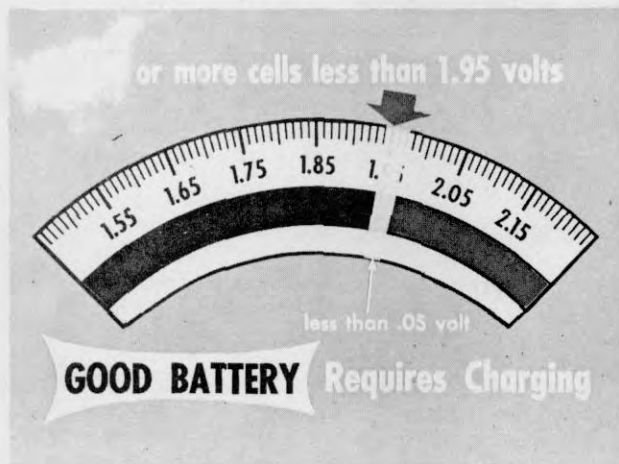

Plate 8307.

5. If cells read both above and below 1.95 volts and the difference between highest and lowest cell is less than .05 volt, battery is good but requires charging.



Plate 8308.

6. If any cell reads 1.95 volts or more and there is a difference of .05 volt or more between the highest and lowest cell, the battery is defective.

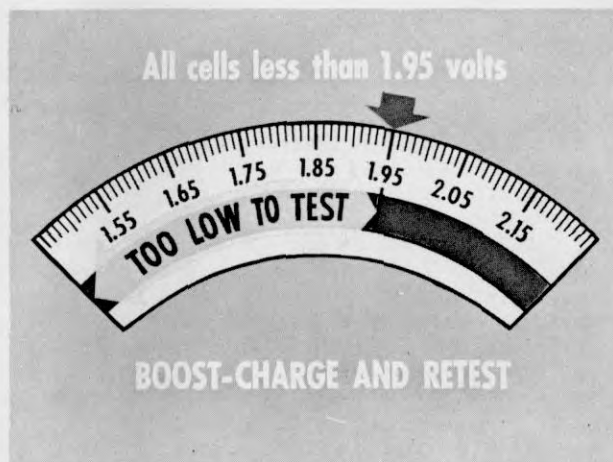
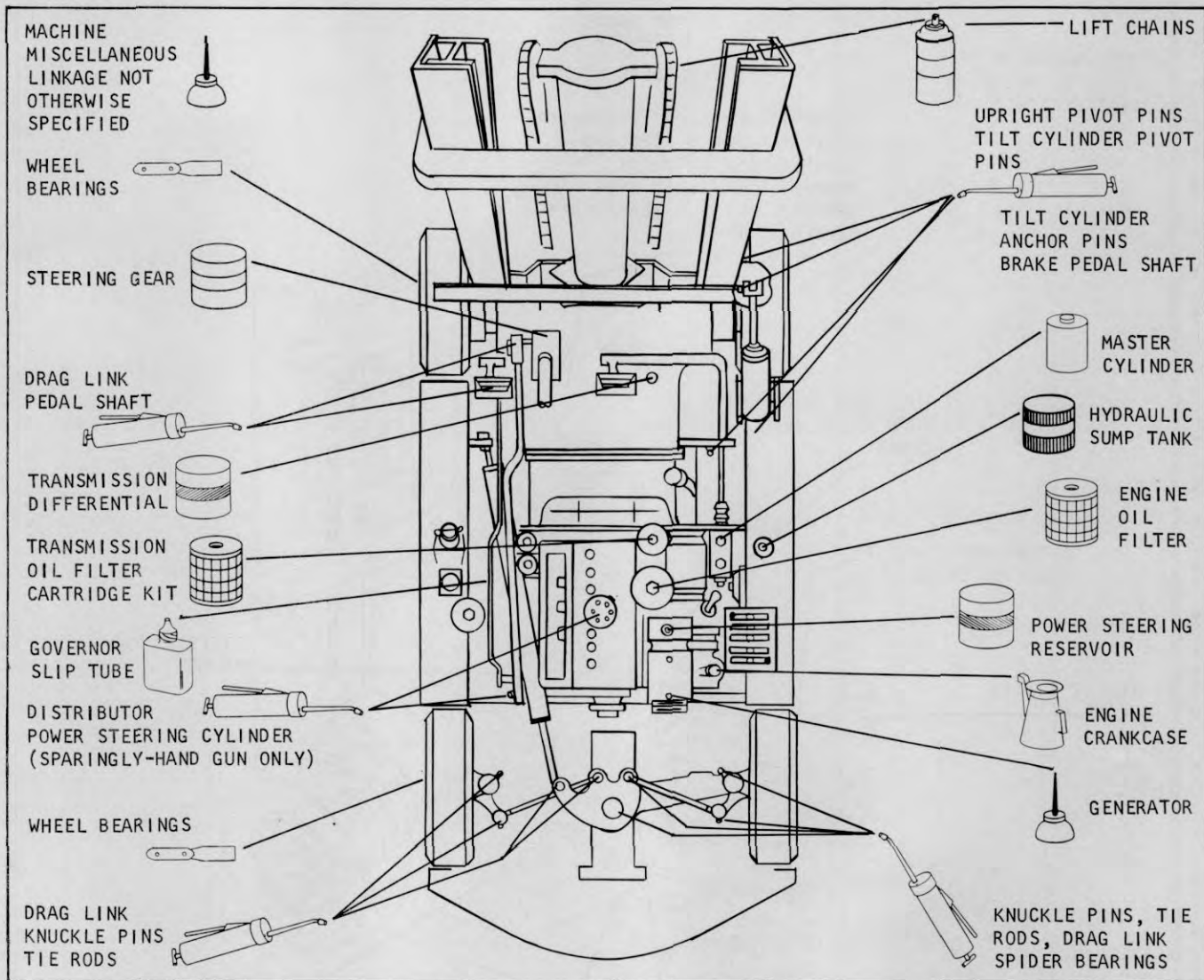

Plate 8309.

7. If all cells read less than 1.95 volts, battery is too low to test accurately. Boost-charge and repeat light load test.



- CHASSIS GREASE
- ENGINE OIL: S.A.E. 20
- GEAR LUBE: S.A.E. 90
- OIL FILTER CARTRIDGE KIT
- 1800200 HYDRAULIC BRAKE FLUID HEAVY DUTY S.A.E. 70R3
- 879803 AUTOMATIC TRANSMISSION FLUID TYPE "A", SUFFIX "A" (CAN MUST HAVE NUMBER PREFIXED BY "AQ-ATF").

- HYDRAULIC FLUID - CLARK SPECIFICATION MS-68 885385
- ENGINE OIL--S.A.E. 10W 0 deg-32 deg F S.A.E. 20W 32 deg-75 d F. "Service MS" S.A.E. 30 above 75 deg F. Or use 10W-30 MULTI-GRADE OIL.
- GRAPHITE GREASE
- 886399 CHAIN LUBE
- WHEEL BEARING GREASE SPEC. MS 9C GREASE
- AXLE ENDS-#1 EP LITHIUM SOAP GREASE

LUBRICATION AND PREVENTIVE MAINTENANCE

500 HOURS

CHECK SECURITY OF ALL NUTS, BOLTS, AND CAPSCREWS.

STEAM CLEAN MACHINE

TRANSMISSION AND DIFFERENTIAL DRAIN - CLEAN SCREEN AND REFILL - USE AUTOMATIC TRANSMISSION FLUID TYPE "A" SUFFIX "A" ----- CLARK PART NUMBER 879803

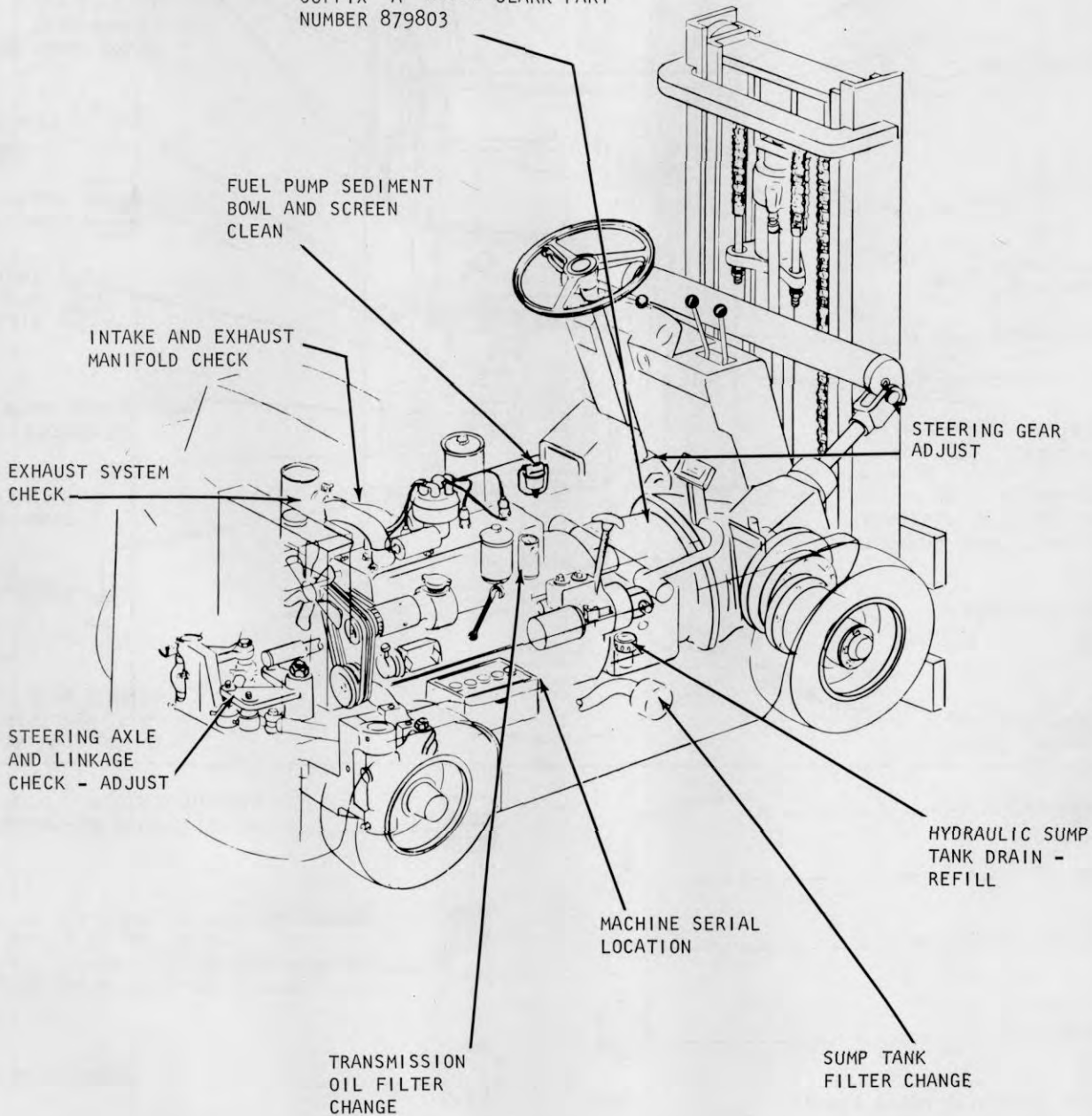

Plate 9482. Lubrication and Preventive Maintenance Illustration

**FUEL PUMP STRAINER**

The fuel filter and sediment bowl should be cleaned every 500 operating hours. Remove and clean sediment bowl. If fuel strainer is dirty, install a new strainer assembly and gasket. Do not reuse old gasket.

**FUEL PUMP**

To determine if the fuel pump is defective, remove the fuel tank supply line at the pump and blow out line with compressed air to remove any possible obstructions. Reconnect fuel tank line and disconnect pump to carburetor line. Install a fuel pressure gauge, by placing a "T" in the line, and run engine at 1800 R.P.M. with all lines connected. Fuel pump pressure should be between 1 1/2 and 2 1/4 lbs. If the fuel pump pressure is not within this range the pump should be removed for repair or replacement.

**C A U T I O N**

TO MINIMIZE ANY POSSIBLE FIRE HAZARD,  
DO NOT SPILL GASOLINE.

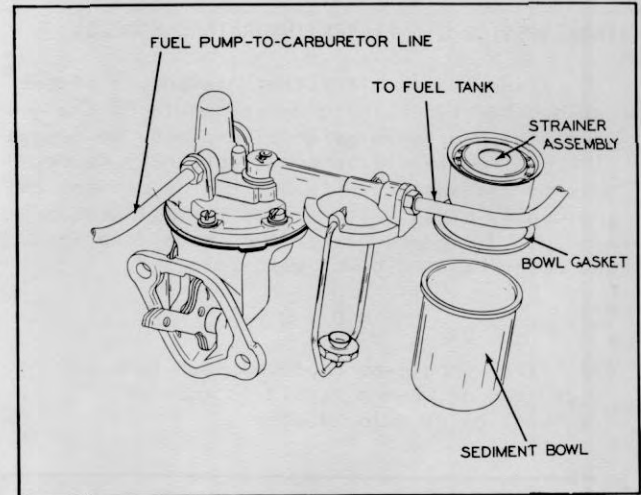

Plate 6432. Fuel Pump & Sediment Bowl

**TRANSMISSION OIL FILTER (HYDRATORK MODELS)**

Transmission oil filter element is of the replaceable type. The element should be changed whenever the transmission is drained. To remove element, remove filter cover retainer, cover, gasket, and spring. Lift out filter element and thoroughly clean filter body. Install new element. Use a new gasket and install spring and cover. Secure cover with retainer.

**NOTE**

Oil filter should be replaced each time oil is changed or when a repair is made on transmission or axle adapter.

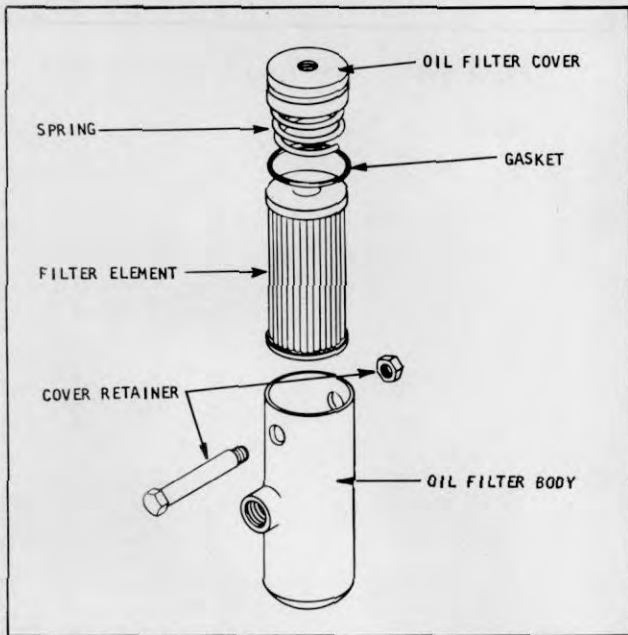

Plate 7234. Transmission Oil Filter

**CONVERTER, AXLE ADAPTER AND TRANSMISSION SUMP SCREEN.**

1. Drain transmission and axle adapter at operating temperatures. See Plate 7301 on following page for location of drain plugs.

**CAUTION**

DO NOT USE FLUSHING OIL OR COMPOUND TO FLUSH SYSTEM.

2. Remove and clean transmission sump screen in a Stoddard type solvent. Dry with filtered compressed air - directing air thru neck of screen.



Plate 7235. Transmission Sump Screen

3. It is recommended that a new "O" ring be used when installing the sump screen.

4. Refill transmission and axle adapter to the full mark as indicated on the dipstick. Use Automatic Transmission Fluid Type "A", Suffix "A". Clark part number 879803. Fluid containers must display a qualification number prefixed by "AQ-ATF".

5. Operate engine for a short period of time to completely charge the converter and plumbing with fluid; then recheck fluid level. To accurately check the fluid level the transmission should be at normal operating temperature, engine running at low idle, and transmission in neutral.

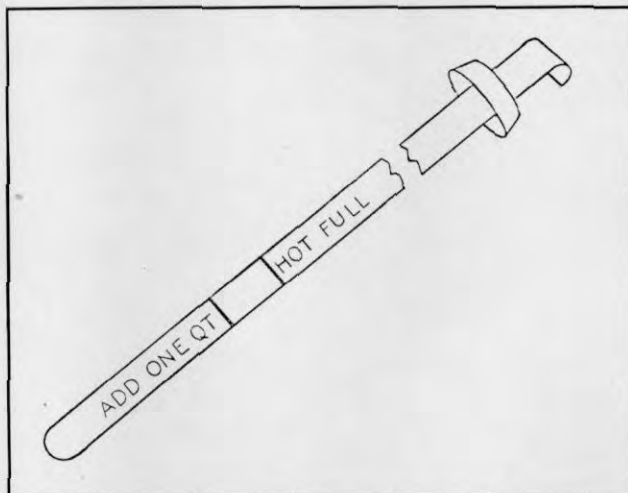

Plate 8281. Transmission Dipstick

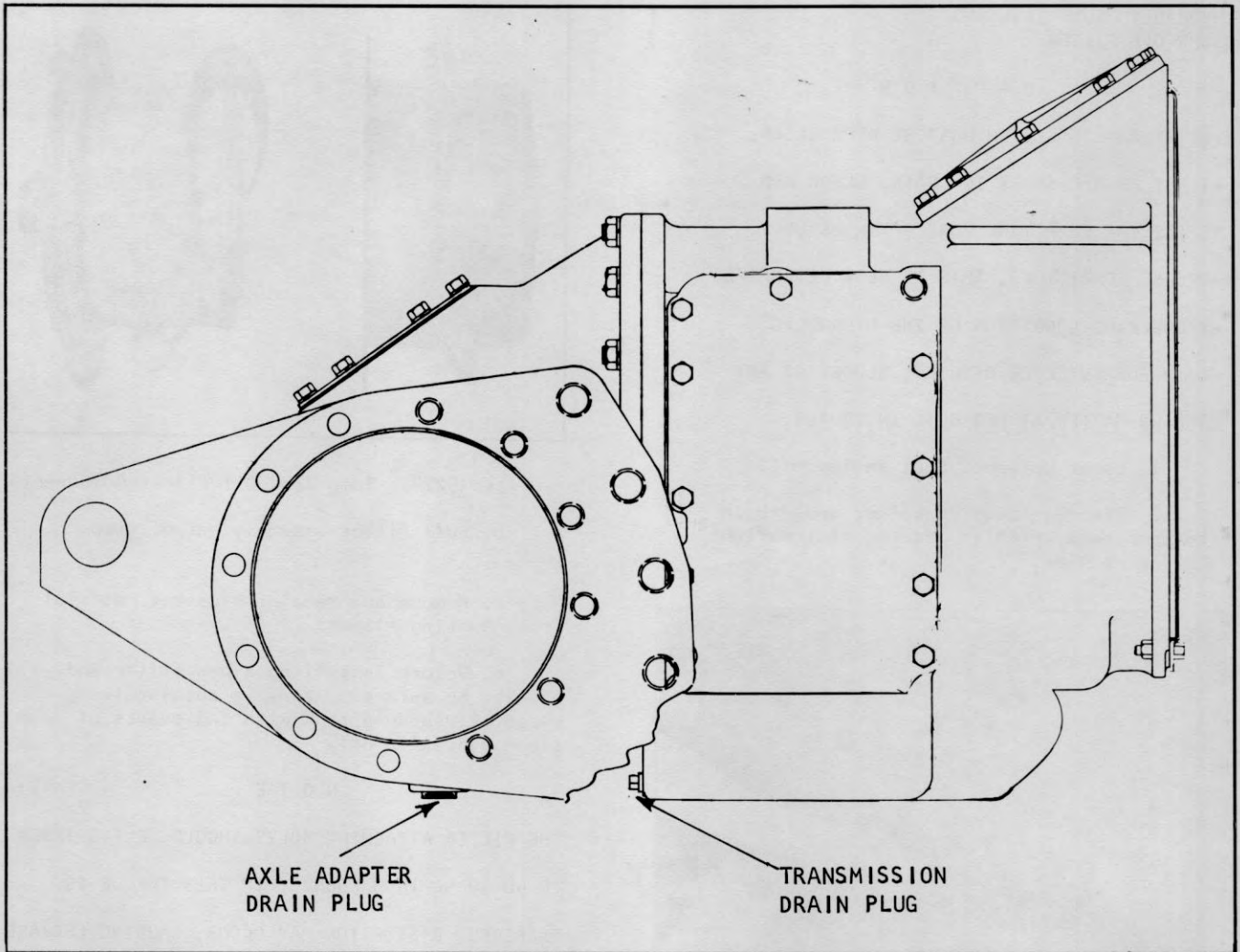

Plate 7301. Axle Adapter and Transmission Drain Plugs

HYDRAULIC SUMP TANK AND  
SUMP OIL FILTER

C A U T I O N

THE HYDRAULIC SYSTEM MUST BE KEPT CLEAN. IT MAY BE NECESSARY TO DRAIN, CLEAN AND REFILL THE SUMP TANK MORE OFTEN UNDER ADVERSE CONDITIONS. THIS IS BEST DETERMINED BY CHECKING CONDITION OF THE HYDRAULIC FLUID FOR EVIDENCE OF DIRT, SLUDGE OR ANY FOREIGN MATTER AT PERIODIC INTERVALS.

1. Lower upright. Shut engine off.
2. Place a large container underneath the sump tank which is located at the right side of machine.

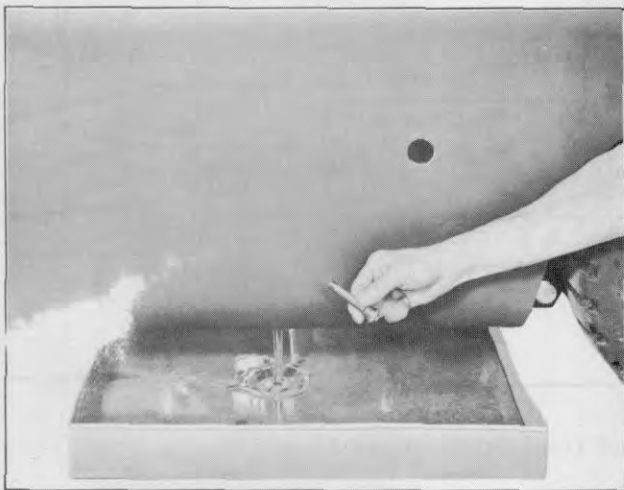

Plate 5359. Draining Sump Tank

3. Remove sump tank drain plug, located at bottom of tank, and allow the fluid to drain. Replace drain plug.

C A U T I O N

DO NOT START ENGINE WHILE SUMP TANK IS EMPTY AS DAMAGE TO THE HYDRAULIC PUMP WILL RESULT.

4. Remove Filter and Clean Sump Tank:
  - a. Disconnect hose and remove filter retainer bolts.

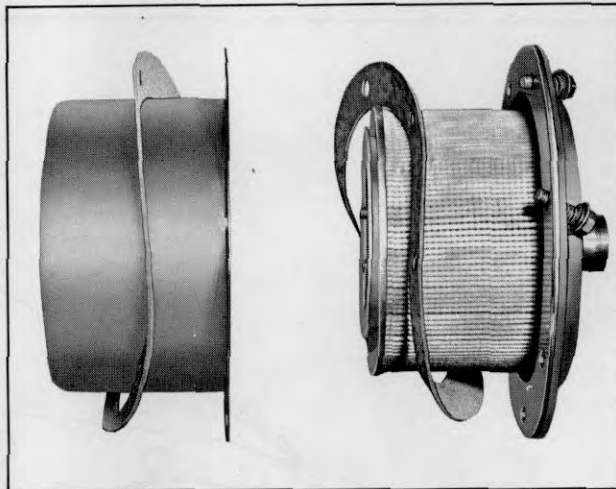

Plate 5274. Sump Tank Oil Filter Components

- b. Pull filter assembly out of sump tank.
- c. Remove any remaining gasket material from mounting flange.
- d. Before installing a new filter and gasket, be sure sump tank is absolutely clean. Flush sump tank with two quarts of clean hydraulic oil.

N O T E

THE FILTER ATTACHING BOLTS SHOULD BE TIGHTENED TO 40 TO 50 INCH POUNDS. IF THIS TORQUE IS EXCEEDED, DISTORTION MAY OCCUR, CAUSING LEAKAGE.

- e. Install hose and tighten hose connections.

5. Fill sump tank with MS 68 Hydraulic fluid until level reaches the bottom of the fill pipe.

C A U T I O N

START ENGINE AND OPERATE HYDRAULIC CONTROL LEVERS SEVERAL TIMES. CHECK OIL FILTER FOR LEAKS, RECHECK OIL LEVEL AND FILL TO BOTTOM OF FILL PIPE IF NECESSARY.



**STEERING GEAR**

Steering gear adjustments must be made in the following manner (see Plates 6636 and 6637).

Always check worm bearing thrust adjustment, and adjust if necessary, before making sector gear lash adjustment.

Before making above adjustments, the following preliminary operations are necessary.

1. Disconnect steering drag link from pitman arm. Note relative position of drag link parts when disconnecting link so the parts may be re-assembled correctly.

2. Check lubricant level in steering gear housing. If low, add enough lubricant to bring level up to filler plug hole. (Use AMOCO Lithium Multipurpose Grease or its equivalent.)

3. Tighten steering gear housing to frame side member bolts, see Plate 6636.

4. Determine straight-ahead position of steering mechanism by turning steering wheel to extreme right.

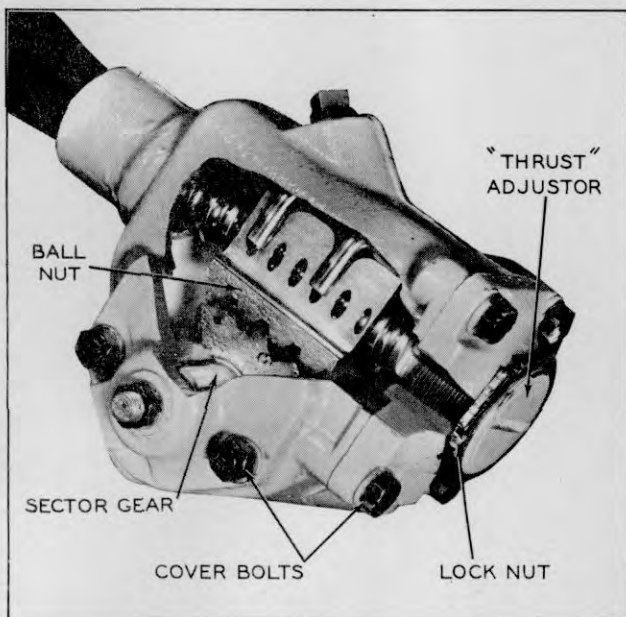

Plate 6636. Steering Gear Thrust Adjustment (Worm Bearings)

**CAUTION**  
APPROACH EXTREME ENDS CAUTIOUSLY; WORM BALL NUT MUST NOT STRIKE ENDS WITH ANY DEGREE OF FORCE.

Then turn to extreme left, counting the exact number of turns from right to left end. Turn wheel back one-half number of wheel turns. Mark wheel with respect to steering column so center position may readily be found during adjustment procedures.

Worm Bearing THRUST Adjustment: Refer to Plate 6636 and proceed as follows:

1. Check tightness of cover bolts, see Plate 6636. Loosen lock nut and turn lash adjuster screw (Plate 6637) counter-clockwise a few turns to provide clearance between sector gear and worm ball nut.

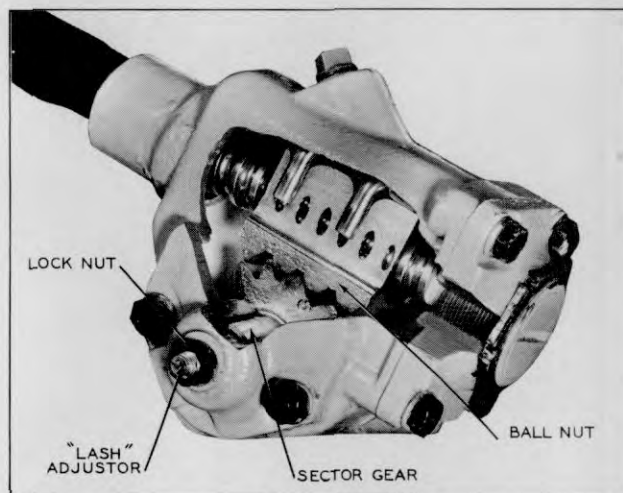

Plate 6637. Steering Gear Lash Adjustment (Sector Gear)

2. Turn steering wheel GENTLY to one extreme end. Turn wheel back one full turn. With spring scale on spoke of wheel, measure pull required to KEEP WHEEL MOVING. Pull on scale should be made at right angles to wheel spoke. If pull is within 1 1/2 to 2 pounds, proceed to lash adjustment in the following paragraphs. If pull is not within 1 1/2 to 2 pounds, adjust worm bearings. The pitman shaft adjustment must be made if worm bearing check is accomplished, or if the worm bearings are adjusted.

3. If it is necessary to adjust the worm bearings, loosen lock nut and then turn worm bearing adjuster nut clockwise until all end play is removed, see Plate 6636. Using spring scale, as directed in Step 2, check pull and readjust as necessary; then tighten lock nut securely.



# INDUSTRIAL TRUCK DIVISION



## LUBRICATION AND PREVENTIVE MAINTENANCE

Sector Gear Lash Adjustment: Refer to Plate 6637, and proceed as follows:

1. Steering Gear Mechanism must be in straight ahead position as previously explained.

2. Turn lash adjuster screw clockwise to remove all lash between gear teeth. Tighten adjuster screw lock nut. Position spring scale on steering wheel so pull may be made at right angles to wheel spoke.

3. Measure pull while wheel is TURNED THROUGH CENTER POSITION. Readjust if reading is not within 2 1/2 to 3 pounds.

4. Tighten adjuster screw lock nut, check pull again.

5. After adjustments are made, install drag link on pitman arm.

### N O T E

IF STEERING LINKAGE ADJUSTMENT IS NECESSARY  
DO NOT INSTALL DRAG LINK TO PITMAN ARM.

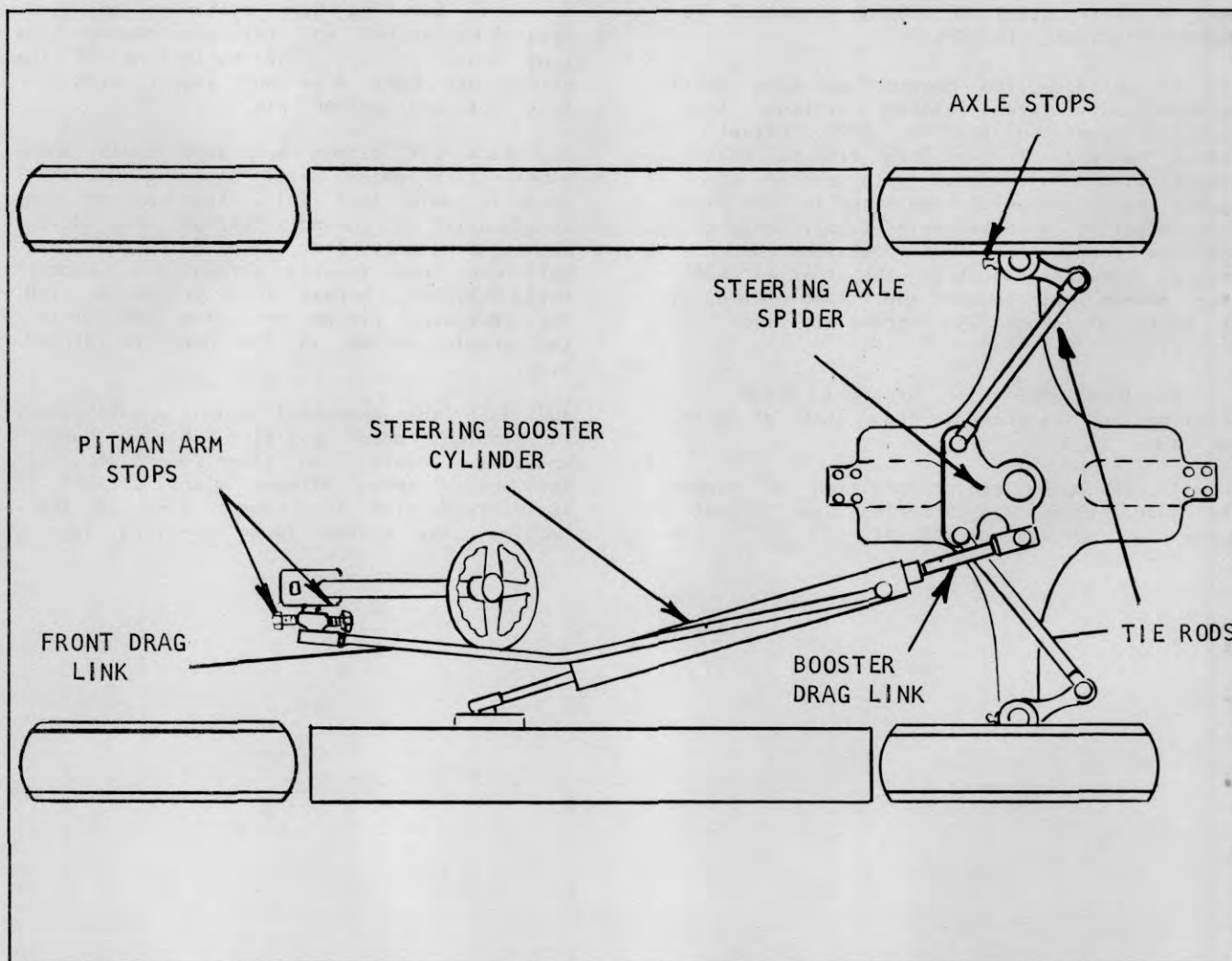

Plate 7340. Steering Linkage

**STEERING AXLE AND LINKAGE ADJUSTMENTS**

1. Raise the steering wheels far enough to clear the floor and place heavy blocking under the machine frame so it cannot accidentally become lowered during adjustments.

2. The steering wheels should track square with the drive wheels with no toe-in or toe-out. If adjustment is necessary loosen the lock nuts at the tie rod ends and turn each tie rod in a manner so they will be the same length when the correct adjustment is obtained. Tighten tie rod lock nuts to secure this adjustment.

3. Disconnect the steering booster socket from the steering axle spider noting the relative position of the socket parts so they may be re-installed correctly

after checking wheels for correct turning geometry.

4. Check wheels for correct turning geometry by turning the wheels all the way for a left turn - this should allow the left wheel to attain an angle of 75 degrees to the frame on pneumatic tire machines and 78 degrees on solid tire machines. If an adjustment is necessary, the axle stop on the left side should be turned in or out whichever is necessary to achieve the correct angle. Repeat this procedure in a right turn with the opposite wheel and adjust the right axle stop as required.

**WARNING**

IF THE STEERING BOOSTER CYLINDER IS TO BE ACTUATED UNDER POWER DO SO ONLY WITH THE ENGINE RUNNING AT IDLE SPEED, USING EXTREME



# INDUSTRIAL TRUCK DIVISION



## LUBRICATION AND PREVENTIVE MAINTENANCE

CARE TO KEEP CLEAR OF MOVING LINKAGES TO PREVENT PERSONAL INJURY.

5. Collapse the booster cylinder until bottomed out. Extend booster cylinder from collapsed position 1/4" to 1/2". Adjust socket on end of rear drag link so that grease fitting lines up with center of spider ball. (Wheels remaining in the right turn position against axle stop). Before securing socket lock nut position the booster cylinder so that the control ball stud points out toward the truck frame at an angle of about 45 degrees to the vertical.

6. Turn wheels to straight ahead position and disconnect drag link at pitman arm.

7. Determine center position of steering gear. (Refer to Steering Gear adjustments for correct procedure).

8. With Steering Gear centered; adjust drag link socket so that the grease fitting lines up with the centerline of the pitman arm ball stud and secure with lock nut and cotter pin.

9. Back off pitman arm stop bolts and slowly turn wheel until steering knuckle contacts axle stop bolt. Turn pitman arm stop until it contacts pitman arm. Move pitman arm away from stop bolt and turn bolt one turn towards pitman arm. Lock in this position. Repeat this procedure with the remaining pitman arm stop bolt with the wheels turned in the opposite direction.

10. Turn the handwheel until wheels are in straight ahead position. Remove handwheel and replace on steering column with the center spoke aligned minus or plus 10 degrees with the center line of the machine, the center spoke pointing back.

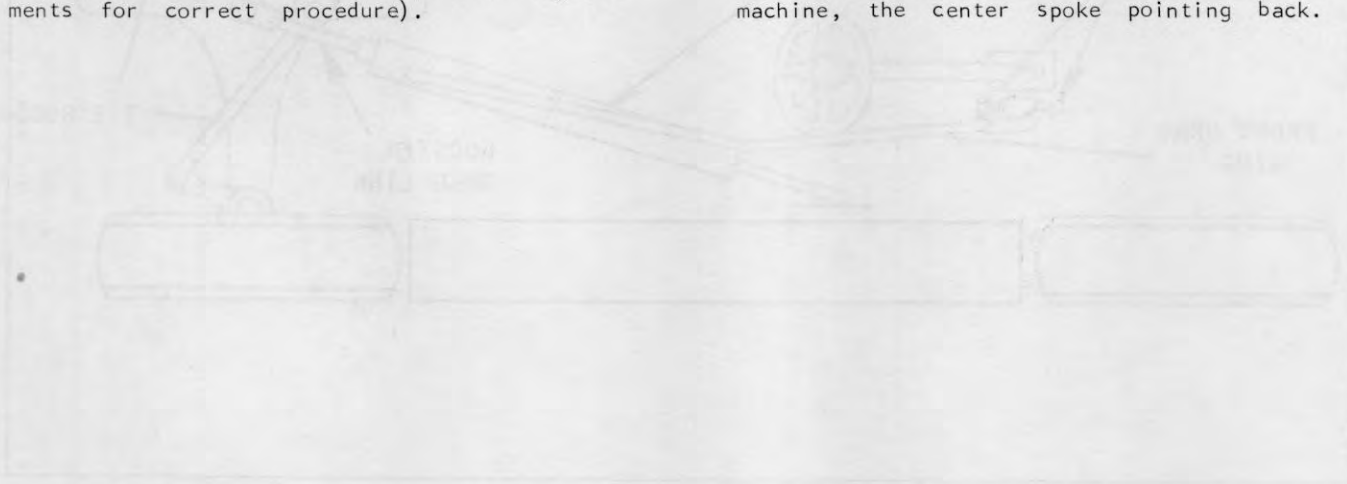

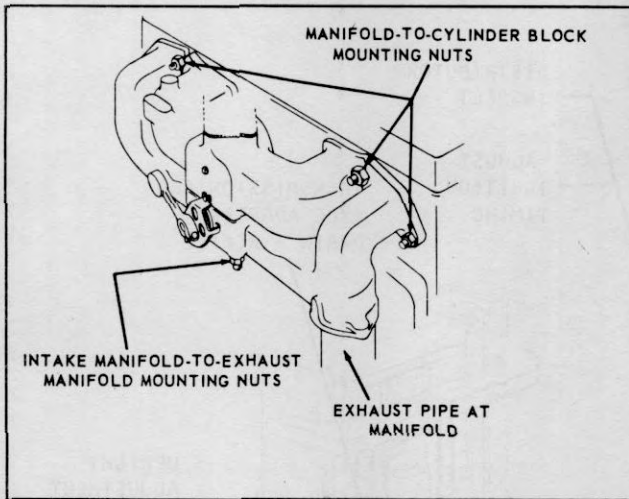
**INTAKE AND EXHAUST MANIFOLDS**

1. Inspect gaskets for leaks and inspect security of manifold nuts.
2. Inspect exhaust pipe and muffler for damage, leakage and security of mountings.

**NUTS, BOLTS AND CAP SCREWS.** Check security of mounting, tighten as required.

Plate 6269. Intake and Exhaust Manifolds

LUBRICATION AND PREVENTIVE MAINTENANCE

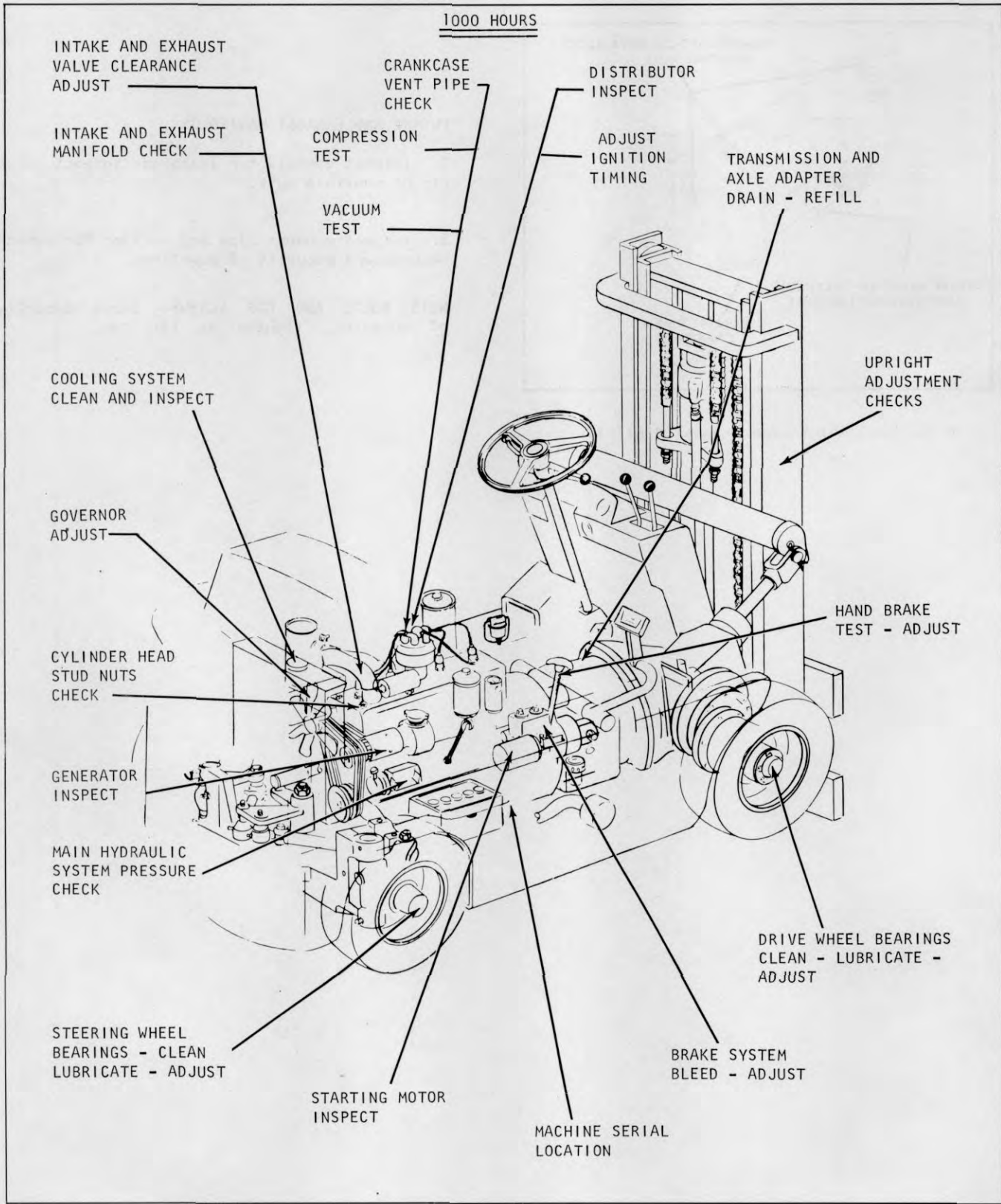

Plate 9484. Lubrication and Preventive Maintenance Illustration

**ENGINE TUNE-UP**

Engine tune-up is the orderly and systematic process of checking the engine and accessory equipment to maintain or restore satisfactory engine performance. Engine tune-up must be accomplished semi-annually and more frequently if engine performance indicates the need for these services. Perform engine tune-up as follows:

1. **AIR CLEANER.** Be sure air cleaner has received proper service. Air cleaner must be installed before making engine tune-up.

2. **FUEL PUMP.** Be sure the fuel pump bowl and strainer has been properly serviced and the fuel pump is operating satisfactorily.

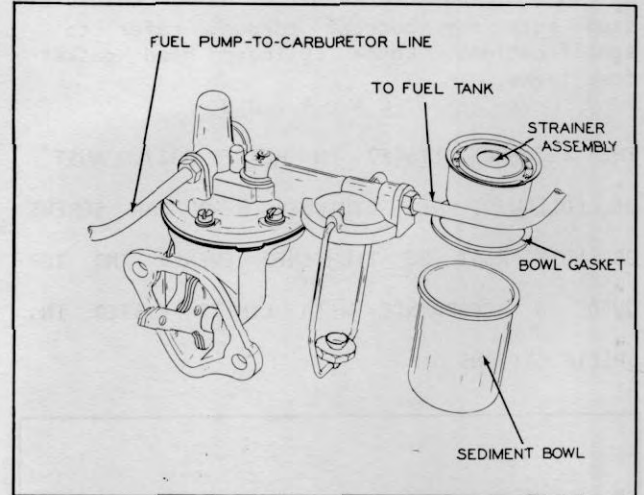

Plate 6432. Fuel Pump Strainer & Sediment Bowl

3. CYLINDER HEAD STUD NUTS. Check all stud nuts for correct torque, refer to specifications. Check cylinder head gasket for leaks.

**C A U T I O N**

THE SEQUENCE LISTED IN PLATE 5927. MUST BE FOLLOWED. ALL CYLINDER HEAD CAP SCREWS OR NUTS MUST BE TIGHTENED EVENLY AND TORQUED IN ACCORDANCE WITH LIMITS LISTED IN SPECIFICATIONS.

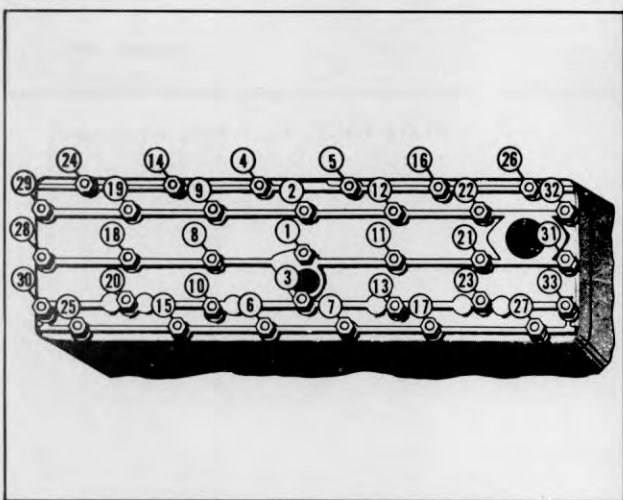

Plate 5927. Cylinder Head Stud Nut Tightening Sequence

4. INTAKE AND EXHAUST MANIFOLDS. Inspect for gasket leaks and security of mounting.

5. CRANKCASE VENTILATION METERING VALVE.

The metering valve connected between the intake manifold and valve cover regulates the amount of air which will flow through the crankcase and is controlled by the engine vacuum.

Remove metering valve and disassemble and wash in a Stoddard type cleaning solvent. Before assembling, put a small quantity of very light oil on the metering pin to prevent sticking until its own lubrication is established. The ventilation tube and valve cover should also be cleaned at the same time, particularly if any noticeable amount of sludge accumulation is found.

After installing the metering valve on the engine be sure hose is in good condition and all connections are properly

sealed to prevent unfiltered air from entering the engine.



Plate 7034. Crankcase Ventilation Metering Valve

6. INTAKE AND EXHAUST VALVE CLEARANCE ADJUSTMENTS.

a. Remove valve chamber cover mounting screws, and the valve chamber cover gasket.

b. With engine running at idling speed and at normal operating temperature, adjust intake valves as follows:

c. Check for proper 0.014 inch clearance by alternately passing a 0.013 inch and a 0.015 inch flat feeler gauge between head of adjusting screw and valve stem, see Plate 3223 on following page.

d. If a 0.013 inch feeler gauge moves freely back and forth in gap when valve is not being lifted and a 0.015 inch feeler gauge binds, at all times, clearance requires no adjustment.

e. If a 0.013 inch feeler gauge is gripped at all times, the clearance is insufficient.

f. Hold valve lifter with an open end wrench while using a second wrench to turn adjusting screw 1/4 to 1/2 turn clockwise. Repeat clearance check and adjustment, until proper clearance is obtained. The adjustable type valve lifters



have self-locking adjusting screws that require no lock nuts.

g. If 0.015 inch feeler moves freely when valve is not being lifted, the clearance is too great. Hold valve lifter with an open end wrench while using a second wrench to turn valve lifter adjusting screw counterclockwise 1/4 to 1/2 turn. Repeat clearance check and adjustment until proper clearance is obtained.

h. Repeat clearance check and adjustment on remaining intake valves.

i. With engine running at idling speed and at normal operating temperature, adjust exhaust valve as follows:

j. Check for proper 0.014 inch clearance by alternately passing a 0.013 inch and a 0.015 inch flat feeler gauge between head of adjusting screw and valve stem cap, See Plate 3223.

k. Follow procedure outlined in paragraphs (d) thru (h).

m. Install valve chamber cover using new valve chamber cover gasket and replace cover mounting screws.

**N O T E**

DO NOT REUSE OLD GASKETS. THEY DO NOT

AFFORD A POSITIVE SEAL.

n. Check valve chamber cover gasket for leaks.

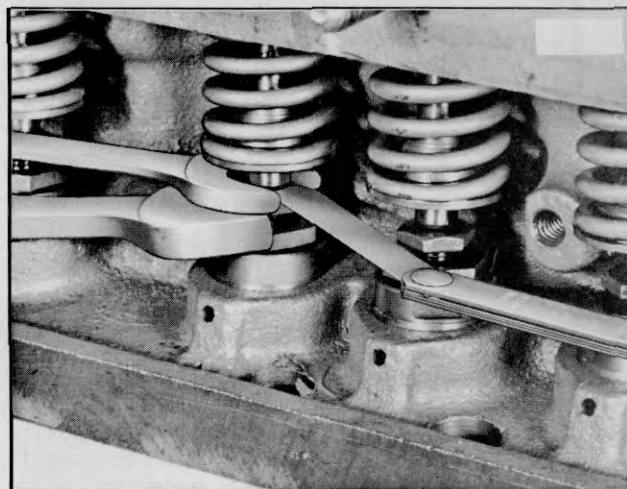

Plate 3223. Adjusting Valve Clearance

**6A. COLD SETTING. (ALTERNATE METHOD)**  
To adjust valve clearance when engine is at room temperature and not running, proceed in the following manner:

a. Remove distributor cap.

b. Crank engine until distributor rotor points to No. 1 cylinder position with the breaker points open. In this position the No. 1 piston is at the top of its compression stroke with both lifters on the base circle of the cam and both valves can be adjusted.

c. Adjust the valve clearance to 0.012 inch on the intake and 0.020 inch on the exhaust. The exhaust (e) and intake (I) valve arrangement on the six cylinder engine is: E-I-I-E-E-I-I-E-E-I-I-E.

d. The other valves may be adjusted by setting the engine with the distributor rotor pointing to the rest of the cylinder positions in the sequence of the firing order which is 1-5-3-6-2-4.



7. COMPRESSION TEST

a. Test battery for full charge (specific gravity 1.280 temperature of 24°C (75°F)). If battery is not fully charged, replace with fully charged battery.

b. Start engine and allow it to warm up until normal operating temperature is reached.

c. Turn off ignition.

d. Remove spark plug cables from spark plugs and remove spark plugs from cylinder head. Examine spark plugs for carbon deposits, defective insulation and general serviceability. All carbon or lead deposits must be removed from the insulation shell and electrodes. This can be done on a sand blast cleaner. Carbon deposits should be removed from the plug threads with a stiff brush. After cleaning, inspect plugs carefully for cracked or broken insulator, badly pitted electrodes or other signs of failure.

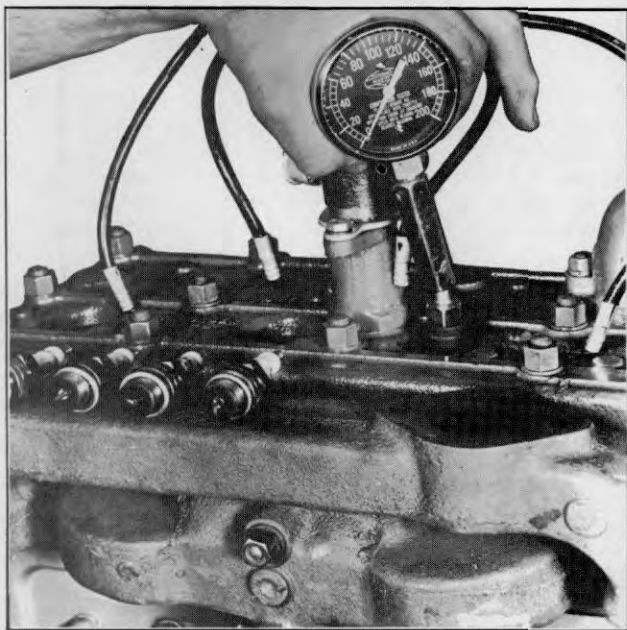

Plate 3486. Compression Test

e. With all plugs removed, install compression gauge in front spark plug port. Operate starting motor until maximum reading on gauge is obtained, see Plate 3486. Record gauge reading. Repeat this operation on each remaining cylinder.

f. If readings are reasonably high (110 to 120) pounds and the readings do not vary more than about 10 pounds between cylinders, compression may be considered normal. Excessively low readings or readings that vary more than 10 pounds between cylinders indicate internal trouble to be corrected after further examination and testing.

g. Set the spark plug gap as specified, by bending side electrode only. The gap should be checked with a wire feeler gauge rather than a flat type gauge as it is better suited for this purpose.

h. Spark Plug Specifications:

Resistor Type - .035" Gap

i. Replace spark plugs using new gaskets. Always replace spark plug gasket whenever a spark plug is removed from the engine. Before installing plugs, be sure that the spark plug seat in the cylinder head is clean and free from obstructions. The spark plug should be screwed into cylinder head (using a socket of proper size) sufficiently tight to fully compress the gasket. This is most important as a large percentage of troubles due to overheated spark plugs are caused by plugs being too loose in the cylinder head. Conversely, excessive tightening may change the gap between the electrodes or crack the insulator.



Plate 3278. Check Spark Plug Gap

8. DISTRIBUTOR

Inspection: Remove distributor cap (without removing wires). Wipe cap with a clean cloth. Examine rotor and cap for chips, cracks, corroded terminals, carbon runners (paths which will allow high-tension leakage to ground) or if the vertical faces of the inserts are burned -- install a new cap and rotor, as this is due to the rotor being too short.

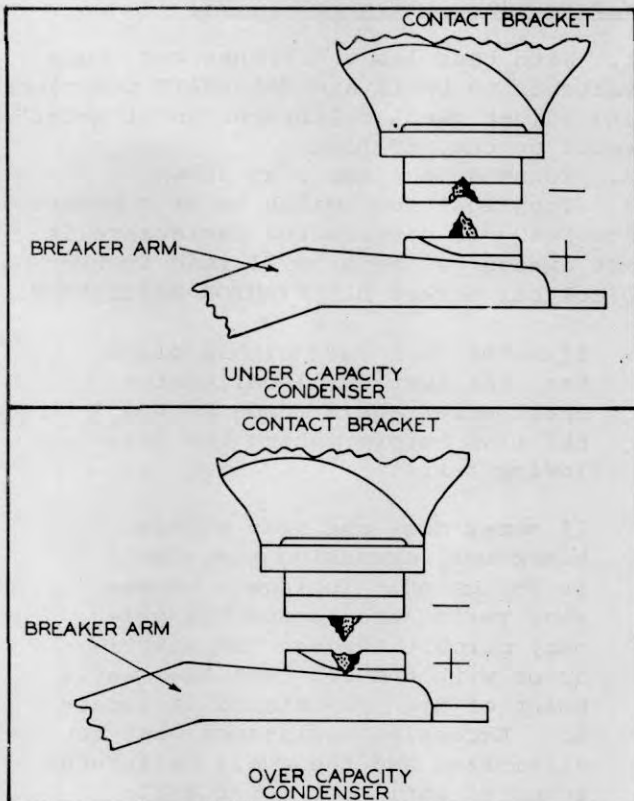

Plate 5933. Breaker Points

Check the centrifugal advance mechanism for "freeness" by turning the breaker cam in the direction of rotation and then releasing it. The advance springs should return the cam to its original position without sticking.

Inspect breaker points. If points are pitted, burned or worn to an unserviceable condition, install a new set of points.

The normal color of contact points should be a light gray. If the contact point surfaces are black, it is usually caused by oil vapor, or grease from the cam. If they are blue, the cause is usually excessive heating due to improper

alignment, high resistance or open condenser circuit.

Badly pitted points may be caused by a defective or improper condenser capacity.

If the condenser capacity is too high, the crater (depression) will form in the positive contact. If the condenser capacity is too low, the crater will form in the negative contact, see Plate 5933.

For a temporary repair, dress the contact points with a few EVEN strokes using a clean fine-cut contact file. DO NOT ATTEMPT TO REMOVE ALL ROUGHNESS OR DRESS THE POINT SURFACES DOWN SMOOTH. See Plate 7475.

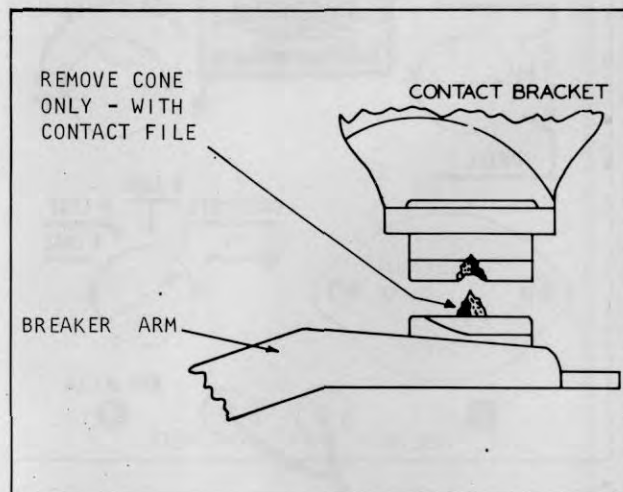
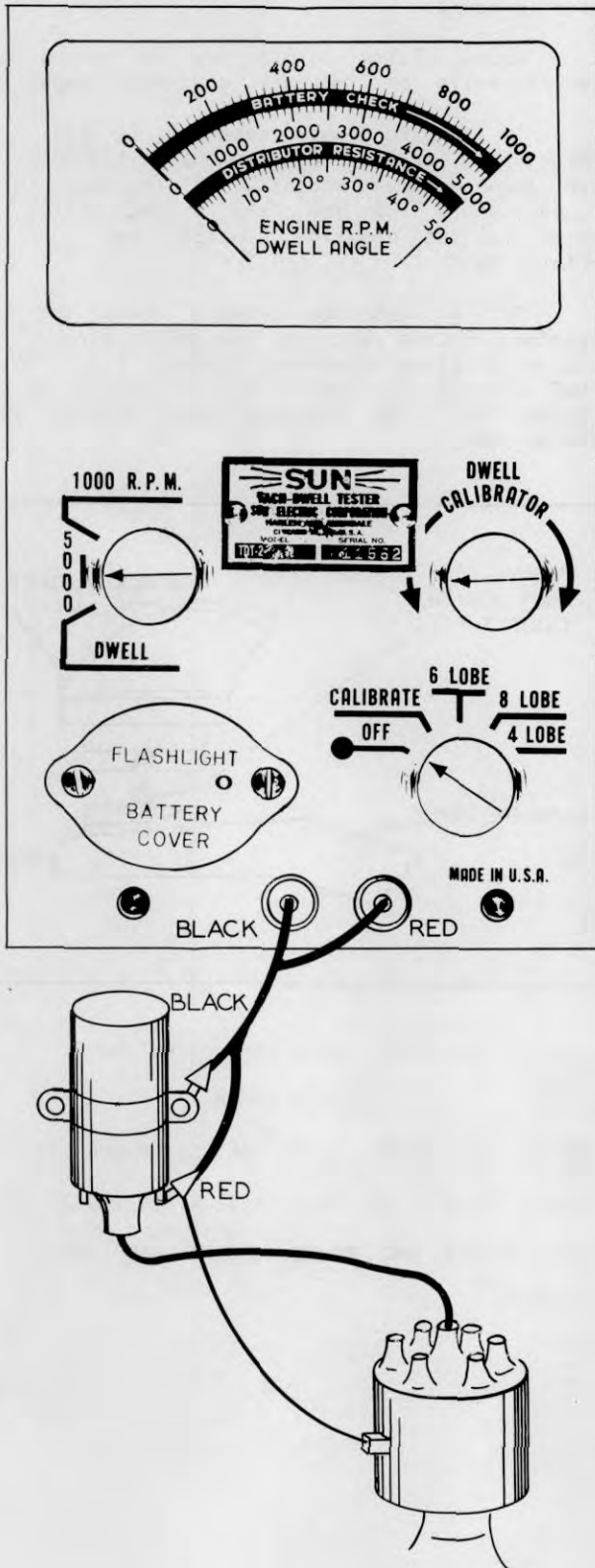

Plate 7475. File Contact Points

CAUTION

NEVER USE EMERY CLOTH OR SANDPAPER TO CLEAN POINTS AS PARTICLES WILL EMBED IN THE POINTS AND CAUSE ARCING AND RAPID BURNING.



MEASURING ENGINE SPEED

1. Connect the test leads as shown.
2. Turn switch to the *LOBE* position corresponding to the number of cylinders.
3. Turn the other switch to the 1000 rpm position for all idle and low speed testing. Use the 5000 rpm position for all speeds over 1000 rpm.

DISTRIBUTOR RESISTANCE TEST

1. With test leads disconnected, turn switches to *DWELL* and *CALIBRATE* positions and adjust dwell calibrator until meter reads on the *SET LINE*.
2. Connect test leads as shown.
3. Turn ignition switch *ON* with engine stopped. If distributor resistance is not excessive, meter will read in the black bar marked *DISTRIBUTOR RESISTANCE*.

If meter does not read within black bar, readjust dwell calibrator until meter again reads on the *SET LINE* before making the following tests.

If meter does not read within black bar, excessive resistance is indicated. To locate excessive resistance, trace the primary circuit through the distributor with the red test lead until point of high resistance is located. Excessive resistance must be eliminated and the dwell calibrator adjusted until the meter again reads on the *SET LINE* before proceeding with the following tests.

DWELL AND DWELL VARIATION TESTS

1. Turn switch to the proper *LOBE* position.
2. Operate engine at idle speed and note reading on dwell scale of meter. Refer to specifications for proper dwell.
3. Turn tachometer switch to the 5000 rpm position and increase speed to 1500 rpm.
4. Turn switch back to the *DWELL* position and again note dwell reading. Slowly reduce speed to idle while watching meter. Dwell should not change more than 3 degrees in either case.

Plate 6887 Tach Dwell Meter

Contact Point Adjustment: The point opening of new points can be checked with a wire feeler gauge, but the use of a feeler gauge on older, rough points is not recommended, since accurate gauging cannot be done on such points. The gauge measures between high spots on the points instead of the true point opening. Point opening of used points can be checked with a Dwell Angle Meter. A meter of this type indicates the cam or contact angle. This angle is the number of degrees that the breaker cam rotates from the time the points close until they open again. The cam angle increases as the point opening decreases and it is reduced as the point opening is increased. Manufacturers of this type equipment furnish complete instructions as to their use.

**N O T E**

REFER TO SPECIFICATIONS FOR DWELL ANGLE AND CONTACT POINT OPENING.

To check point opening with a feeler gauge, insert a wire feeler gauge of proper size between the contact points. MAKE CERTAIN THAT THE BUMPER BLOCK ON THE MOVABLE CONTACT IS AT THE HIGH POINT ON THE CAM. If adjustment is necessary, loosen the lock screw, and insert a screwdriver of the proper size in the adjustment slot and move the stationary arm until the correct clearance is obtained. Tighten locking screw and recheck point gap. See Plate 7457.

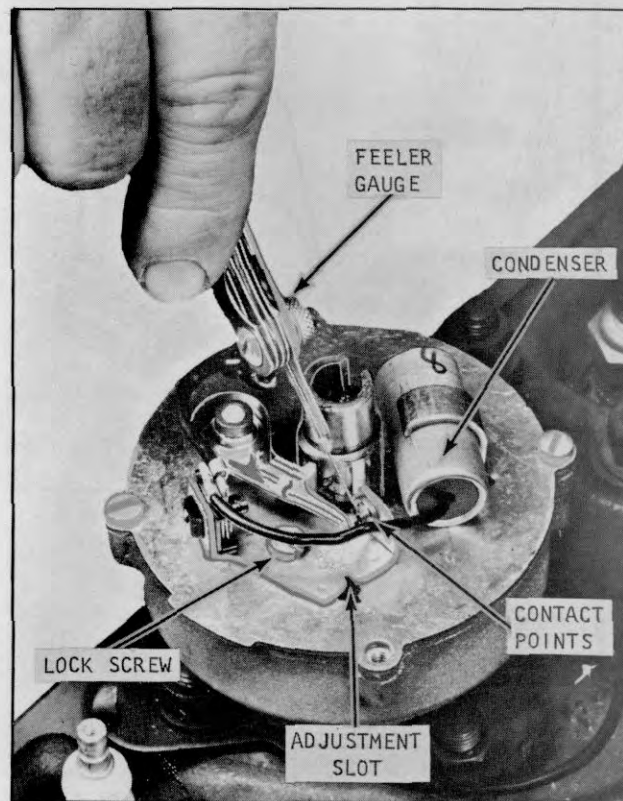

Plate 7457. Contact Point Adjustment

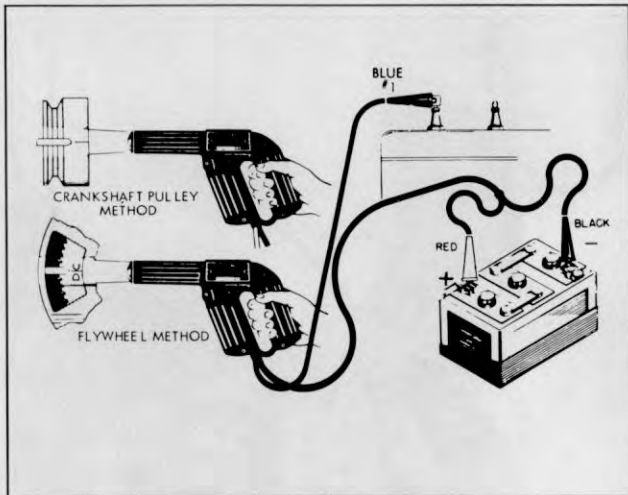
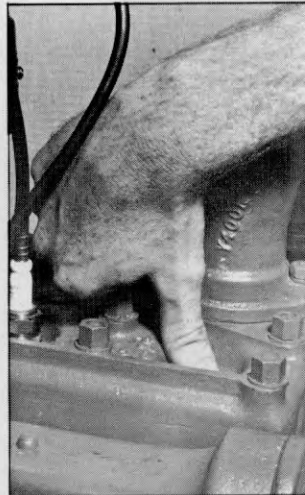

Plate 7818. Timing Light Hookup



ADJUST SO POINTER IS ON MARK LISTED IN SPECIFICATIONS

Plate 7861. Ignition Timing

9. IGNITION TIMING

There are two methods of checking ignition timing --- with or without a timing light. The PREFERRED METHOD is to use a timing light in following sequence:

Paint a line on the flywheel (or in some cases, on the front pulley) so the correct timing mark will be more legible under the timing light.

- a. Clip blue secondary lead of light to the #1 spark plug -- leave spark plug wire on plug.
- b. Connect primary positive lead (red) to positive terminal of battery.
- c. Connect primary negative lead (black) to negative battery terminal.
- d. Start engine and run at 400 RPM or below so the automatic advance of the distributor is completely retarded. THIS IS VERY IMPORTANT TO OBTAIN CORRECT TIMING.

**NOTE**

The initial advance RPM range is 430-580. Distributor advance at 600 engine RPM should be 1° to 5°.

e. Direct timing light on the pulley (or flywheel through opening in bell housing) and note timing marks as light flashes. The light should flash on the timing mark that is listed in specifications.

f. To advance timing, turn distributor body clockwise. To retard timing, turn distributor body counterclockwise.

- g. When timing is correct, tighten distributor clamp screw securely. Then recheck timing again with light.

ALTERNATE TIMING METHOD

- a. Remove #1 Spark Plug -- put your thumb over the spark plug hole and crank engine by hand until air is exhausting.
- b. Continue to slowly crank engine until the mark listed in specifications lines up with the pointer in bell housing.
- c. Loosen the distributor clamp bolt and rotate the distributor body until the contact points just start to open. (This may be more accurately checked by means of a test lamp connected between the distributor primary lead and the negative terminal of the battery -- when the points are closed the light will be ON and as soon as the points break the light will go OFF.)
- d. Tighten distributor mounting bolts.

10. VACUUM TEST

Before making vacuum test, make certain cylinder head is securely tightened and that cylinder head gasket is not leaking. Air cleaner must be installed and must be clean to perform vacuum test. Manifold stud nuts must be tight and there must not be any leakage at gasket.

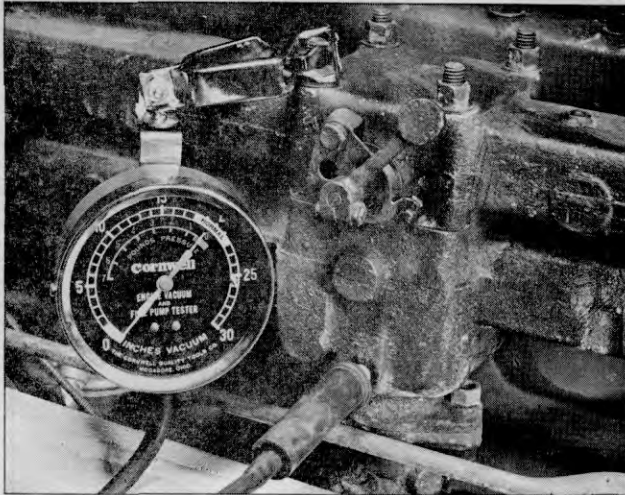

Plate 6643. Vacuum Test

(a) Remove plug at intake manifold and install vacuum gauge, see Plate 6443. Using the tachometer, set the engine idle speed at 450 to 500 RPM.

Idle Speed Adjustment: A stop screw controls action of the throttle valve. Turn screw clockwise for faster idle speed, or counterclockwise for slower idle speed. This adjustment should be made with a tachometer. Idling speed should be set for 450 to 500 revolutions per minute. Reset idle mixture screw if necessary, after throttle adjustment has been made, see Plate 6889.

(b) Check the vacuum gauge. A steady reading from 18" to 22" of mercury is a normal reading, indicating that valve and spark timing, valve seating, and piston ring sealing are all satisfactory.

(c) A steady but below normal reading indicates a condition common to all cylinders such as a leak at the carburetor gasket, late ignition or valve timing, or uniform piston ring and bore wear.

(d) A slowly fluctuating or drifting reading indicates that the fuel idle mixture is incorrect. Look for the cause in the fuel system.

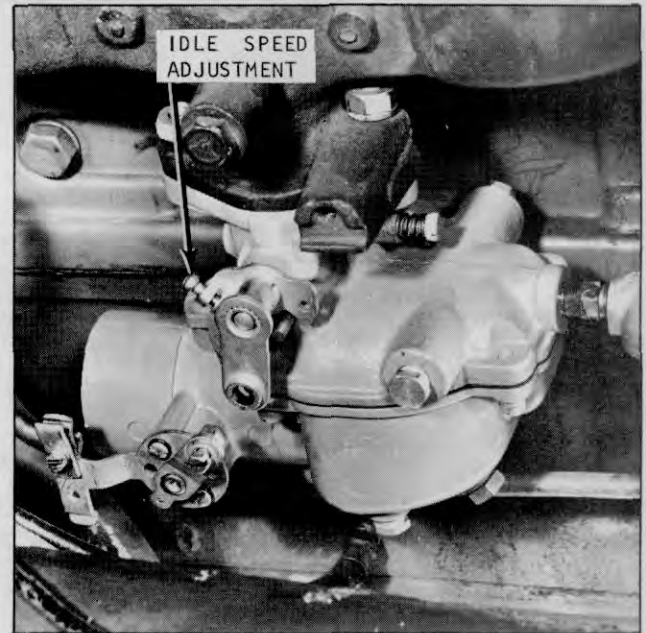

Plate 6889. Idle Speed Adjustment

(e) A rhythmic pulsating reading is caused by a condition affecting one or more cylinders, but not all, and indicates leaky valve, gasket blow-by, restricted intake port, or an electrical miss.

(f) An intermittent pulsating reading is caused by an occasional malfunction, such as a sticking valve (all valves may be erratic in operation if the valve springs are weak), electrical miss caused by insufficient distributor point tension or low coil voltage coupled with inconsistent spark plug gaps or fouled plugs, or dirt in the fuel system finding its way into passages of critical size or valve seats in the carburetor.

(g) A normal reading that quickly falls off (with engine running at approx. 1860 RPM) indicates exhaust back pressure caused by a restriction in the exhaust system.

(h) Make indicated corrections to bring vacuum to 18" to 22" of mercury normal reading.

Idle Fuel Adjustment: The carburetor is controlled by the idle adjustment screw that regulates the fuel-air mixture, see Plate 6889. Turning the screw clockwise, towards the seat, cuts off air increasing the suction on the idle jet and making the mixture richer. Turning the idle adjusting screw counterclockwise, or away from seat, allows more air to be mixed with the fuel making a leaner mixture for idling.

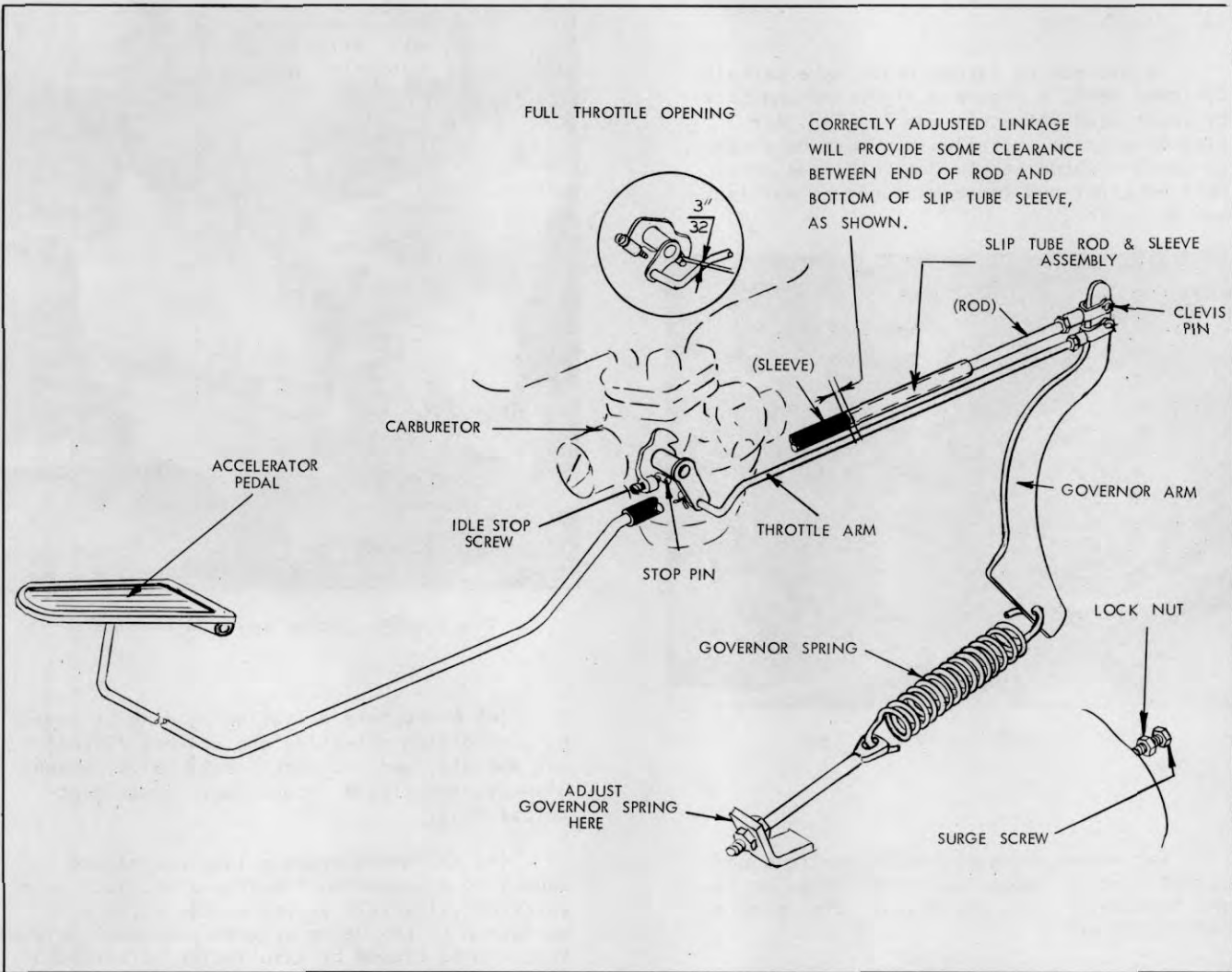

Plate 6660. Governor Adjustment

11. GOVERNOR ADJUSTMENT

With timing set on top dead center, and the carburetor properly adjusted to idle at 500 R.P.M., proceed with the following:

A. Loosen Governor Surge Screw Jam Nut and back Surge Screw out.

B. Disconnect Slip Tube Rod from Governor Arm by removing Clevis Pin.

NOTE

REMOVE CLEVIS PIN --- DO NOT LOOSEN CLEVIS JAM NUT.

C. Pull rod from Slip Tube Sleeve and thoroughly clean rod and sleeve. Lubricate rod with Graphite Grease after cleaning.

NOTE

THE SLIP TUBE ROD AND SLEEVE ASSEMBLY CANNOT FUNCTION PROPERLY IF IT IS BINDING, THEREFORE, THE ASSEMBLY MUST BE CLEAN AND PROPERLY LUBRICATED TO CORRECTLY ADJUST THE GOVERNOR.

D. With the Slip Tube and Sleeve Assembly disconnected, the Governor Arm will move forward. Check the Carburetor Throttle Opening. There should be 3/32 inch clearance between the Full Throttle Opening Stop and Stop Pin on the carburetor.

If adjustment is necessary, adjust the Throttle Rod between carburetor and





# INDUSTRIAL TRUCK DIVISION



## LUBRICATION AND PREVENTIVE MAINTENANCE

governor arm until the specified clearance (3/32 inch between STOP and STOP PIN) is obtained.

E. Push the Governor Arm toward rear of machine until the Idle Stop Screw contacts Stop Pin on the carburetor. Rotate the Governor Surge Screw inwards until screw comes in contact with the Governor Shaft Lever (when holding the Governor Arm rearward) ---- Do Not Rotate Screw So Far That The Idle Stop Screw Moves Away From Stop Pin. When correct surge screw adjustment is obtained, tighten jam nut.

F. With the use of an Electric Tachometer, start engine (Warm up to normal temperature) and check for NO -- LOAD 2350 R.P.M.

### NOTE

GOVERNED R.P.M. SHOULD BE CHECKED WITH THE SLIP TUBE ROD DISCONNECTED BETWEEN THE ACCELERATOR LINKAGE AND THE GOVERNOR ARM.

If adjustment is necessary, adjust the Governor Spring, see Plate 6660.

G. Install Slip Tube over rod. Attach Rod Clevis to Governor Arm with Clevis Pin.

### IMPORTANT

WITH IGNITION OFF, DEPRESS ACCELERATOR PEDAL AND CHECK THROTTLE OPENING. IF THERE IS MORE THAN 3/32 INCH CLEARANCE BETWEEN THE FULL THROTTLE OPENING STOP AND STOP PIN (ON THE CARBURETOR), ADJUST THE SLIP TUBE CLEVIS, OR ACCELERATOR PEDAL LINKAGE TO OBTAIN THIS DIMENSION.

H. Start engine and again check for NO - LOAD 2350 R.P.M.

If specified R.P.M. is not obtained, check for binding linkage, bent Slip Tube, etc., free up, straighten or repair as required.

**STARTING MOTOR**

1. Remove end plate (or Brush Cover) from starter. Use a wire hook to lift a brush spring and remove brush from holder. Compare brush size with that of a new brush. If brush is worn beyond half the original size, or if brushes are jammed, chipped, or broken they must be replaced.

**CAUTION**

NEVER ALLOW SPRING TO SNAP DOWN ON BRUSHES.

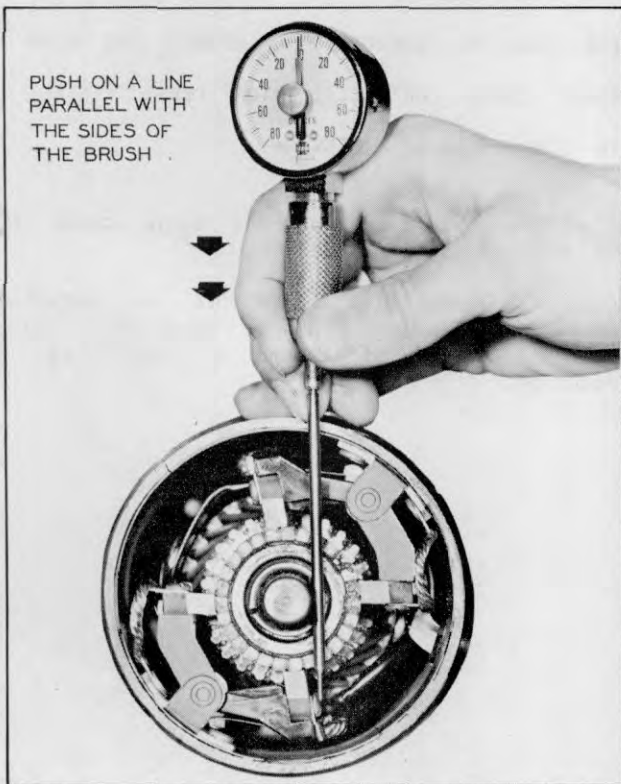

Plate 6449 Checking Brush Spring Tension

2. Check for Brush Spring Tension, refer to Specifications. Refer to the following procedures for checking spring tension.

Measuring Brush Spring Tension - Reaction Type Brushes. Hook the scale under the brush spring near the end and push or pull on a line parallel to the sides of the brush. To assist in telling the exact instant that the pressure is relieved, a small strip of paper can be placed under the brush. Pull slightly on the paper and the paper will slip out at the correct instant for reading the spring scale.

Measuring Spring Tension - Swinging Type Brushes: Hook the spring scale under the brush screw tight

against the brush and push or pull on a line parallel to the sides of the brush. Take the reading just as the brush leaves the commutator. Pulling slightly on a strip of paper which has been placed under the brush will indicate when the brush leaves the commutator and the correct instant for reading the spring scale.

3. If commutator is glazed or dirty, clean with a strip of No. 00 sandpaper. Blow out all dirt and grit with compressed air.

**CAUTION**

DO NOT USE EMERY CLOTH TO CLEAN COMMUTATOR.

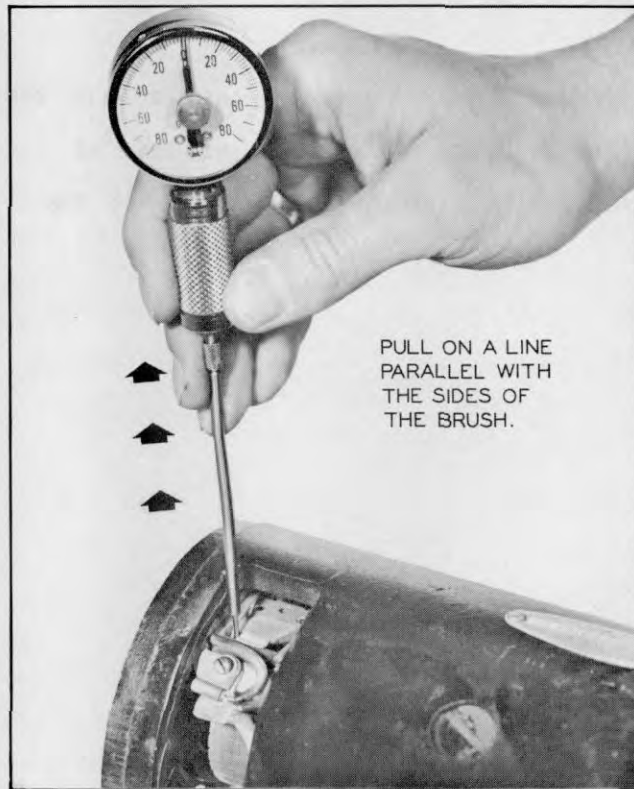

Plate 6450. Checking Brush Spring Tension

Condition Test: Use one of the two following methods to determine whether the starting motor should be removed from the engine for inspection, service or replacement.

1. First Method: Operate the starting motor by disconnecting the battery cable from the solenoid switch and holding the cable terminal firmly against the starting motor terminal, using a battery known to be fully charged and in good condition. To do this it will be necessary to remove the solenoid switch.

2. If the motor reacts correctly, and the drive mechanism engages and disengages each time the starting motor is operated, the starting motor is in good condition.

3. If motor does not react properly, it must be removed for inspection or replacement.

4. Second Method: Using a voltmeter and a battery (fully charged) that is in good condition, connect positive lead of test voltmeter to positive terminal of battery and negative lead of voltmeter to negative (grounded) terminal of battery. Record voltmeter reading. Now pull high-tension wire from ignition coil so engine will not start when starter is engaged. Connect positive lead of test voltmeter to ground and negative lead of test voltmeter to starter switch terminal. Turn ignition switch to start position and note voltmeter reading. Compare this reading with the previously recorded reading. If the voltage drop is more than 4 volts, or if the second reading is below 8 volts, the starting motor should be removed from the engine for further testing and repair, or replacement.

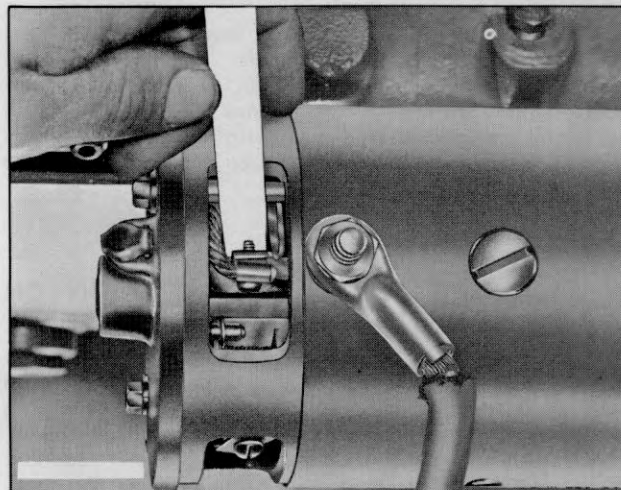

Plate 3436. Seating Brushes

**NOTE**

**BLOW OUT ABRASIVE PARTICLES AFTER SEATING BRUSHES.**

**GENERATOR**

1. Remove end plate (or Brush Cover) from generator. Use a wire hook to lift a brush spring and remove brush from holder. Compare brush size with that of a new brush. If brush is worn beyond half the original size, or if brushes are jammed, chipped, or broken they must be replaced.

**CAUTION**

**NEVER ALLOW SPRING TO SNAP DOWN ON BRUSHES.**

New brushes can be seated with a brush seating stone. When held against the revolving commutator, the abrasive material carries under the brushes, seating them in a few seconds. Blow out abrasive particles after seating brushes. See Plate 3436.

allel to the sides of the brush. To assist in telling the exact instant that the pressure is relieved, a small strip of paper can be placed under the brush. Pull slightly on the paper and the paper will slip out at the correct instant for reading the spring scale.

Measuring Spring Tension - Swinging Type Brushes: Hook the spring scale under the brush screw tight against the brush and push or pull on a line parallel to the sides of the brush. Take the reading just as the brush leaves the commutator. Pulling slightly on a strip of paper which has been placed under the brush will indicate when the brush leaves the commutator and the correct instant for reading the spring scale.

3. If commutator is glazed or dirty, clean with a strip of No. 00 sandpaper. Blow out all dirt and grit with compressed air.

**CAUTION**

**DO NOT USE EMERY CLOTH TO CLEAN COMMUTATOR.**

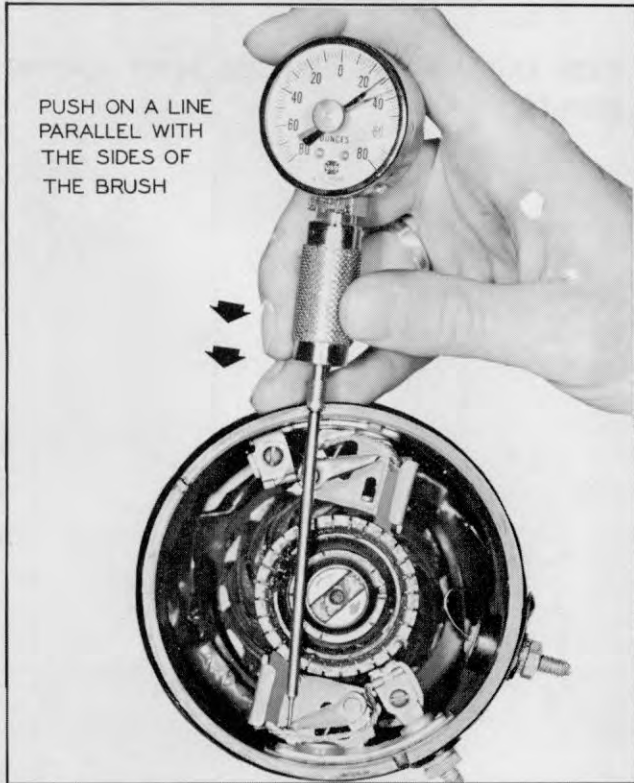

Plate 6451. Checking Brush Spring Tension

Using a spring scale, check for proper brush spring tension. Refer to Specifications. Refer to the following procedures for checking spring tension.

Measuring Brush Spring Tension - Reaction Type Brushes. Hook the scale under the brush spring near the end and push or pull on a line parallel

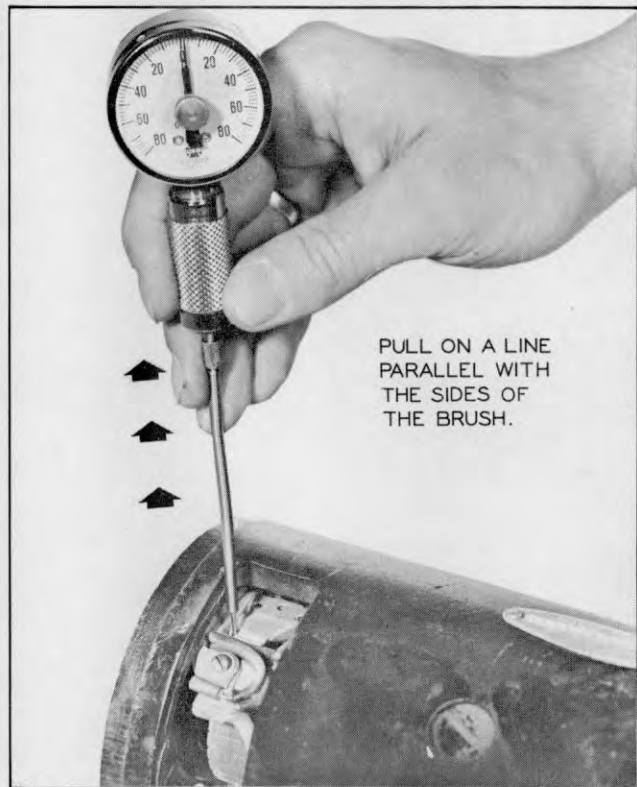

Plate 6450. Checking Brush Spring Tension

## NOTE

BLOW OUT ABRASIVE PARTICLES AFTER SEATING BRUSHES.

## REGULATOR

Inspect regulator leads for frayed or worn condition. Check to make certain that leads are tight and securely mounted.

## WIRING

Check all wires for loose or corroded connections and for fraying. Replace defective wires.

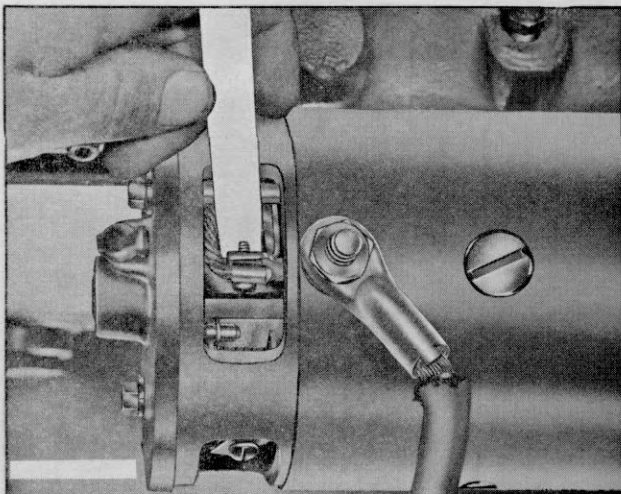

Plate 3436. Seating Brushes



Plate 6640. Typical Wheel Bearings

STEERING WHEEL BEARINGS

Adjustment:

1. Raise rear of machine so that tires clear floor.

**WARNING**

AFTER RAISING MACHINE AND BEFORE MAKING ANY ADJUSTMENTS OR ADJUSTMENT CHECKS, PLACE ADEQUATE (HEAVY) BLOCKING (SUFFICIENT TO SUPPORT THE WEIGHT OF THE MACHINE) UNDER THE FRAME TO PREVENT ACCIDENTAL LOWERING OR FALLING OF THE VEHICLE, THUS PREVENTING PERSONAL INJURY TO MECHANIC OR BYSTANDERS.

2. Inspect adjustment of bearings by gripping top and bottom of tire, chuck tire 'in' and 'out' to determine looseness or wobble.

**NOTE**

BEFORE MAKING WHEEL BEARING ADJUSTMENTS, BE SURE PLAY (LOOSENESS OR WOBBLE) IS IN THE WHEEL BEARINGS AND NOT IN THE KING PINS.

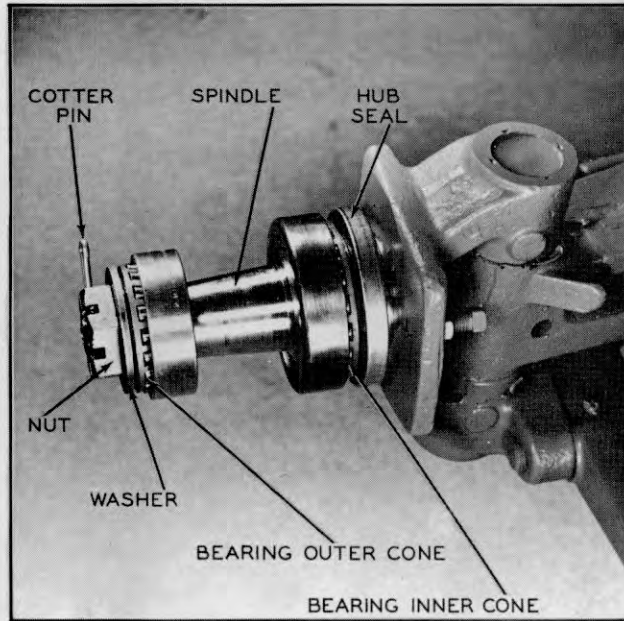

Plate 6703. Typical Wheel Bearings

**NOTE**

IF WHEEL BEARINGS NEED ADJUSTING, CLEAN AND REPACK BEARINGS BEFORE MAKING ADJUSTMENTS. REFER TO LUBRICATION PARAGRAPH. BEFORE REPACKING WHEEL BEARINGS, CHECK FOR ANY INDICATION OF LEAKAGE AROUND HUB SEALS. IF SUCH A CONDITION EXISTS, REPORT TO DESIGNATED PERSON IN AUTHORITY.

3. If looseness or wobble is in the wheel bearings, remove hub cap and spindle cotter pin, see (Plate 6640). Tighten nut with a 12" wrench, and at the same time rotate the wheel in one direction and then in the other until there is a slight bind to be sure all bearing surfaces are in contact. Then back off the nut 1/6 to 1/4 turn allowing the wheel to rotate freely. Secure nut at this position with a new cotter pin and replace hub cap.

Lubrication:

1. Remove wheels after 1000 hours or every six months of operation. Clean bearings and repack with medium bodied high temperature wheel bearing grease, Clark Specification MS9C.
2. Install wheels and adjust wheel bearings as previously described.

**CLEAN AND REPACK AXLE ENDS**

Every 1000 operating hours remove and repack the axle ends.

1. Tilt upright back. Place solid heavy blocks under each upright rail. Tilt upright forward until vertical to the floor. This should allow the drive wheels to clear the floor. Remove drive wheels.

**WARNING**

ON PNEUMATIC TIRE MACHINES DEFLATE TIRES BEFORE REMOVING WHEELS.

2. Remove hub cap, outer spindle nut, lockwasher, inner spindle nut and washer. Pull hub assembly from spindle.

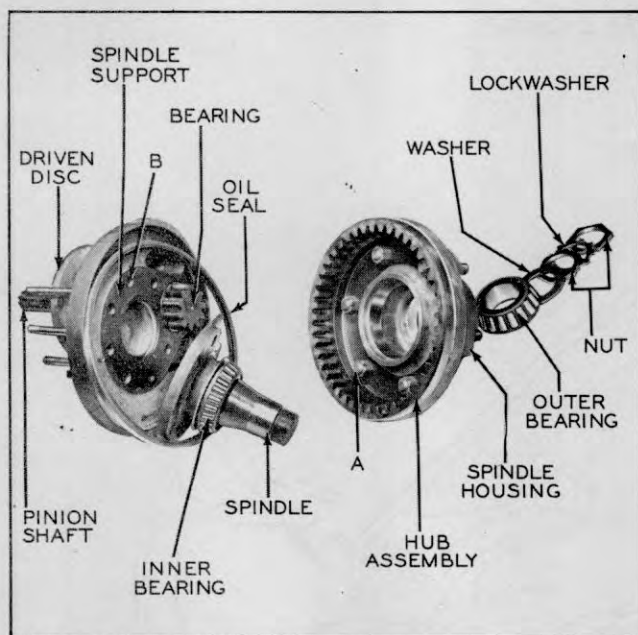

Plate 5694. Axle End Assembly

3. Remove bearings and clean in a Stoddard type cleaning solvent. Slop bearings up and down in solvent. Remove and tap large side of bearing against a block of wood to dislodge solidified particles of lubricant. Repeat operation until bearings are thoroughly clean. Blow bearings dry with compressed air. Direct air stream across bearing to avoid spinning. Slowly rotate bearing by hand to facilitate drying. Dip bearings in gear oil and wrap in paper until they are to be reinstalled.

4. Pack all bearings with NLGI #1 (Amolith grease EP #1 or its equivalent) before final assembly. Also pack the hub cavity between the

bearings 1/2 full. (As an alternate grease No. 1 E.P. lithium soap grease may be used).

5. Clean ring gear, pinion drive shaft, hub assembly, spindle and spindle support.

6. Inspect seals for cuts, scratches and nicks. It is necessary to replace seal if such a condition is found. Check the axle end vent for obstruction, vent must be open. See Plate 6893.

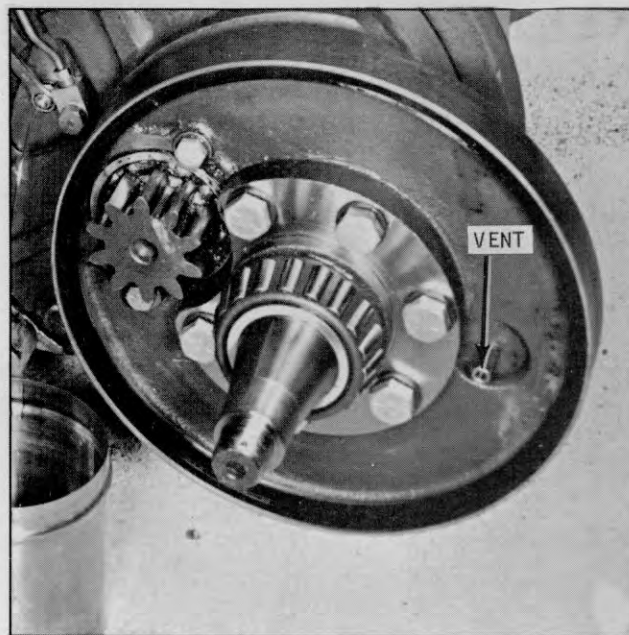

Plate 6893. Typical Axle End Vent

7. Pack the spaces between the teeth of the ring gear and pinion, level full for the entire circumference with NLGI #1 (Amolith grease EP #1 or its equivalent). The approximate amount of grease in this area is to be 1 1/4 pounds.

8. Install bearings, seal and hub assembly on spindle. Tighten inner bearing adjusting nut until bearings bind slightly during rotation. Back off adjusting nut approximately 1/8 turn and lock with outer nut. Secure this adjustment by bending the tangs on the lock washer. Install the hub cap.

9. Replace drive wheels and tires. Inflate tires if they are of the pneumatic type. Tilt upright back and remove blocking.

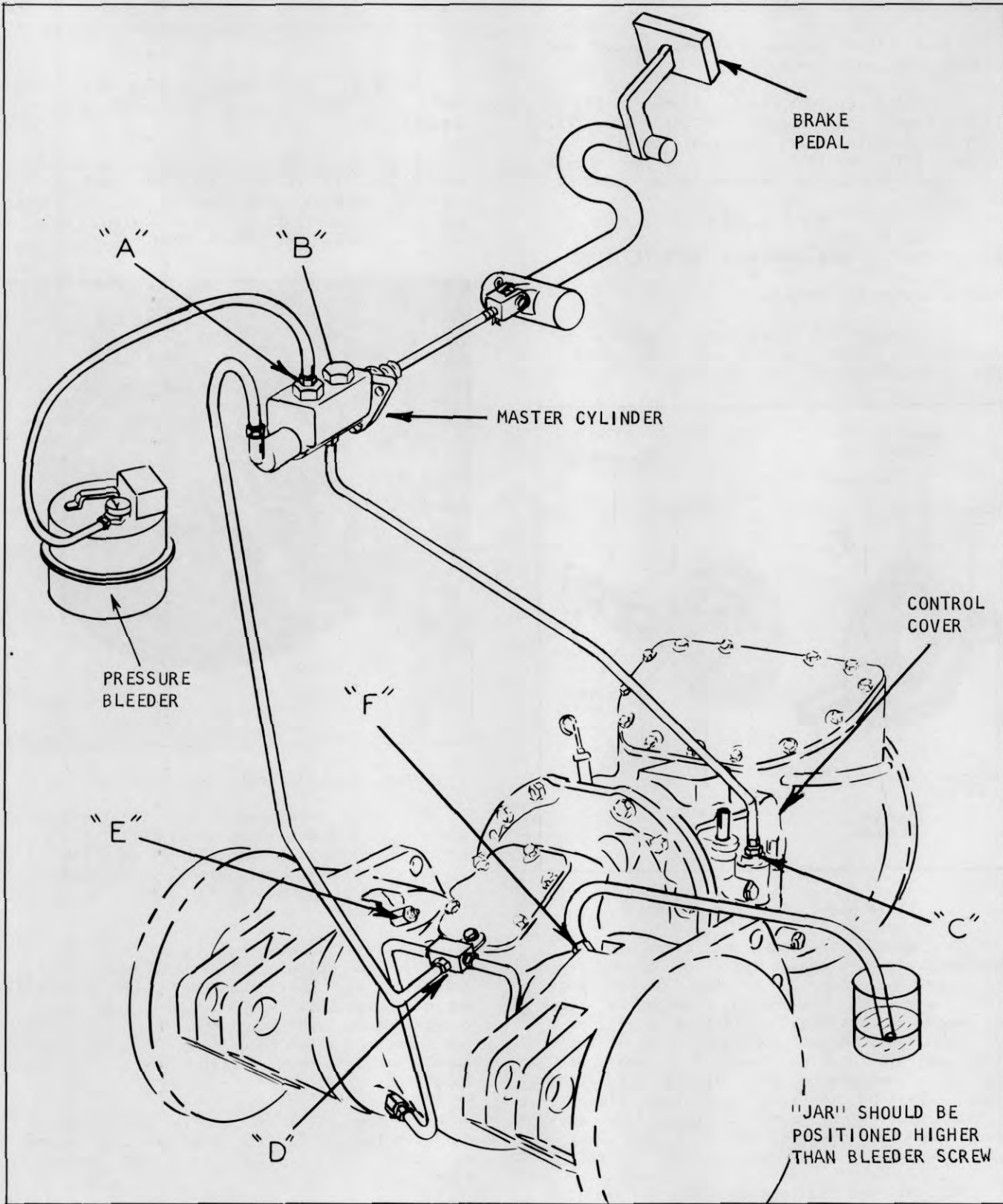

Plate 7302. Bleeding Brakes





# INDUSTRIAL TRUCK DIVISION



## LUBRICATION AND PREVENTIVE MAINTENANCE

### BRAKE BLEEDING PROCEDURE

Proper operation of the hydraulic brake system requires a solid column of fluid without air bubbles at all points in the pressure system. Under certain conditions it becomes necessary to bleed fluid from the system in order to expel air bubbles which have become mixed with the fluid. The necessity of bleeding is indicated by a soft or spongy pedal, or at any time a brake line is removed (or broken) the system must be bled.

Step 1. Tilt upright back. Place solid heavy blocks under each upright rail. Tilt upright forward until vertical to the floor. This should allow the drive wheels to clear the floor.

#### NOTE

IF DRIVE WHEELS ARE REMOVED FROM MACHINES EQUIPPED WITH PNEUMATIC TIRES, DEFLATE TIRES BEFORE REMOVING.

Step 2. Check the brake pedal free travel (see specifications). Clean dirt from around the filler cap of the master cylinder reservoir. Brake fluid should be within 1/4" of the top. With filler cap off the master cylinder, depress and release brake pedal. A small displacement of fluid should be noticed in the cylinder reservoir. If this happens, the brake pedal (upon being released) is returning the master cylinder piston to its normal position to open a master cylinder port. This port must be open. If fluid does not return to the reservoir (when releasing brake pedal), this indicates improper pedal free travel and a pedal adjustment is required.

#### NOTE

THE KEY LETTERS IN PARENTHESES ARE SHOWN ON OPPOSITE PAGE EXCEPT WHERE OTHERWISE INDICATED.

Step 3. To properly bleed the system it is recommended that a pressure bleeder filled with about two quarts of S.A.E. 70-R-3 heavy duty brake fluid be connected to the master cylinder reservoir. Pressure bleeder should then be pressurized to 10-20 P.S.I.

Step 4. Remove vented filler plug and attach pressure bleeder.

Step 5. Loosen plug (B) to permit air to escape from reservoir. Tighten plug after fluid appears around plug.

Step 6. Loosen tube nut (C) and allow all air to escape. Tighten tube nut.

Step 7. Loosen tube nut (D) and allow air to escape. Tighten tube nut.

Step 8. Install a bleeder hose on bleeder screw (E) and submerge the unattached end of the hose in a clean transparent jar containing several inches of brake fluid. NOTE: DURING BLEEDING THE JAR SHOULD BE ELEVATED TO A POSITION HIGHER THAN THE BLEEDER SCREWS MAKING SURE THAT THE END OF THE HOSE REMAINS SUBMERGED IN THE FLUID AT ALL TIMES. Allow fluid to flow until all traces of air are gone. Tighten bleeder screw. Repeat this operation on opposite bleeder screw (F).

Step 9. After all bleeding has been completed close the pressure bleeder shut-off cock and loosen hose connection at master cylinder to allow pressure to escape. Replace master cylinder cap.

Step 10. If wheels were removed replace them. (Inflate tires if they are of the pneumatic type). Tilt upright back and remove blocking from under each upright rail.

If a pressure bleeder is unavailable the system may be bled manually by following steps six thru eight. It must be remembered that the brake pedal should be depressed slowly and held to the floor-board until the line connections or bleeder screws are securely tightened. This prevents the possibility of air being drawn into the system during the bleeding operation. Check master cylinder reservoir level periodically during manual bleeding and fill to within 1/4 inch of the top as required.

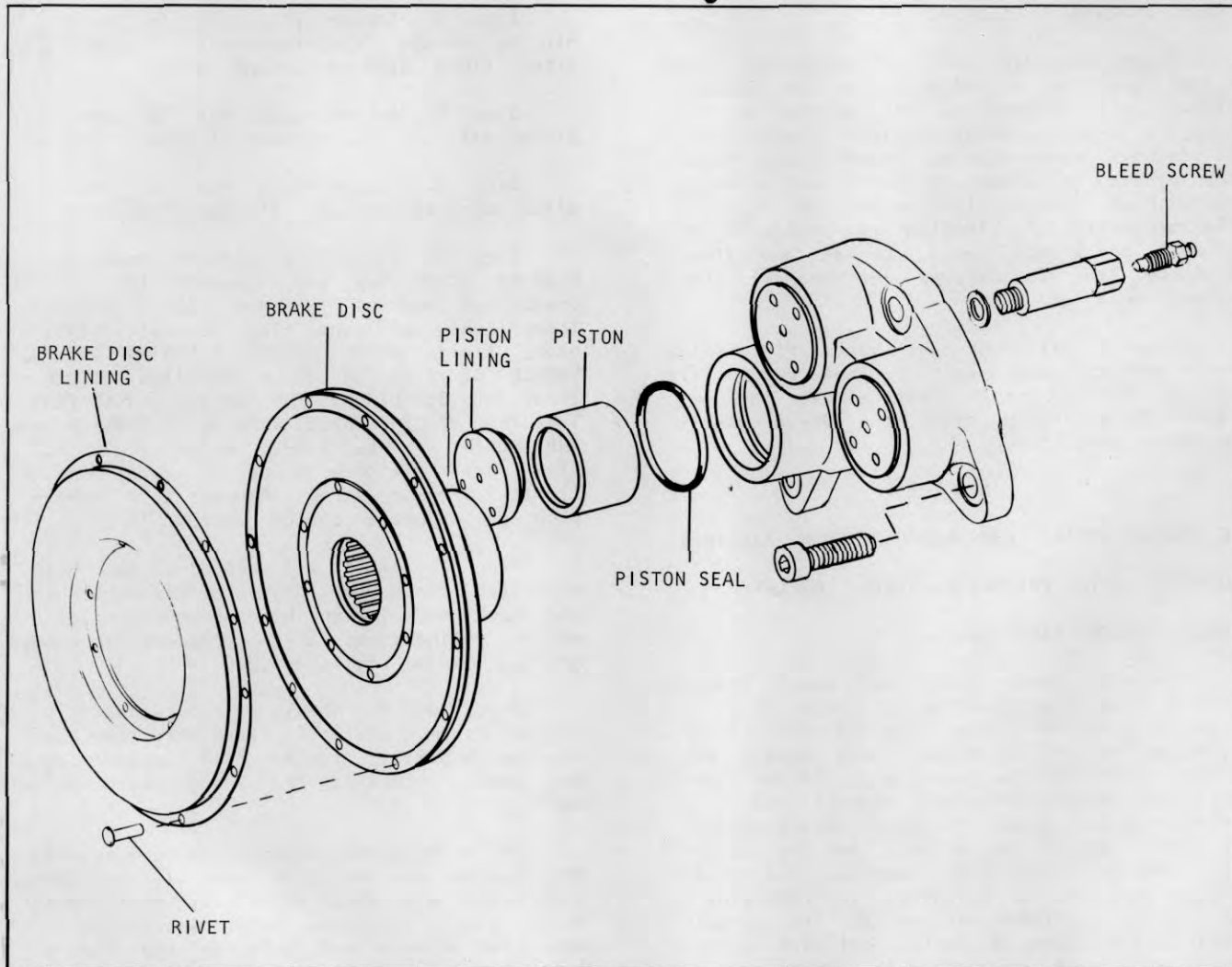

Plate 8261. Wheel Brake Assembly

**DESCRIPTION**

When depressing the brake pedal, hydraulic pressure is applied to the brakes, the pistons move out and their linings force the brake disc and its lining against a member of the axle end producing braking action by friction.

**INSPECTION**

Operating conditions determine the inspection and service periods for the brake linings. If it is found that the brake effectiveness has dropped to a noticeable degree (and the system has been properly bled and pedal free travel is correctly adjusted) the axle ends should be removed so that linings may be inspected to determine their further serviceability.

The original thickness of the brake disc lining is 0.221 inch. The disc lining is effective until it is worn to 1/16 inch thickness. If after inspection it is found that the lining is worn to the extent that it will not be effective until the next inspection period, it should be replaced. The brake piston lining when new is 0.649 inch thick to the step on the lining. This lining should also be replaced if it is determined that it will be worn to within 1/16 of step before the next inspection period.

Before replacing axle ends, check the cylinders for leakage. The actual presence of fluid, other than mere dampness, indicates a fluid leak. Correct leaks as necessary by replacing the piston seals after cleaning the pistons and seal grooves thoroughly.

**PARKING BRAKE ADJUSTMENT**

The mechanical "V" block type parking brake operates on the transmission drive shaft brake drum. The only adjustment necessary during the useful life of the brake lining is a periodic adjustment of the linkage.

To adjust the linkage, remove the floor plates, and adjust the clevis on the linkage, so that the brake handle has 2 inches of upward travel, before resistance is noticed and the brake becomes applied.

The parking brake must be capable of holding the truck, with full rated load, on a 15% grade. This should be tested with the drivers seat occupied, parking brake applied and the truck out of gear.

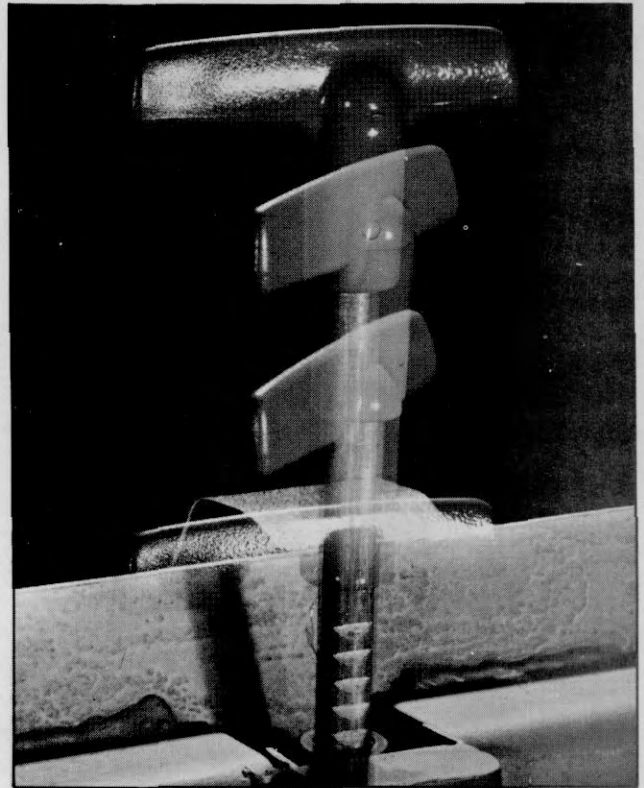

Plate 7482. Parking Brake

COOLING SYSTEM

Radiator Pressure Caps:

**WARNING**

USE EXTREME CARE IN REMOVING THE RADIATOR PRESSURE CAP. IN PRESSURE SYSTEMS, THE SUDDEN RELEASE OF PRESSURE CAN CAUSE A STEAM FLASH AND THE FLASH, OR THE LOOSENED CAP CAN CAUSE SERIOUS PERSONAL INJURY. LOOSEN CAP SLOWLY AND ALLOW STEAM TO ESCAPE.

1. Inspect pressure cap gasket and radiator filler neck to be sure they are providing a proper seal. If the rubber face of the valve is defective, a new cap should be installed.



Plate 6458. Radiator Pressure Cap

2. Inspect pressure cap for freedom of operation.

Pressure caps employ a spring loaded, rubber-faced valve which presses against a seat in the radiator top tank. Pressure caps employ either a vacuum valve held against its seat under spring pressure, or a weighted vacuum valve which hangs open until forced closed by a surge of vapor or coolant. Check to be sure components are free to operate.

**NOTE**

IF A NEW CAP IS REQUIRED, ALWAYS INSTALL A CAP OF THE SAME TYPE AND PRESSURE RATING. PRESSURE RATING 7 LB.

3. Inspect for dented or clogged overflow pipe. To remove clogged material, run a flexible wire through pipe until obstruction is removed.

When a pressure cap opens the sudden surge of vapor or liquid must pass thru the overflow pipe. If the pipe is dented or clogged, the pressure developed by the obstruction may cause damage to radiator or hoses.

Inspect and Clean Cooling System:

Check hose connections for coolant leaks as well as air leakage. Air leakage around hose connections allows oxygen into the system which is a major factor in corrosion.

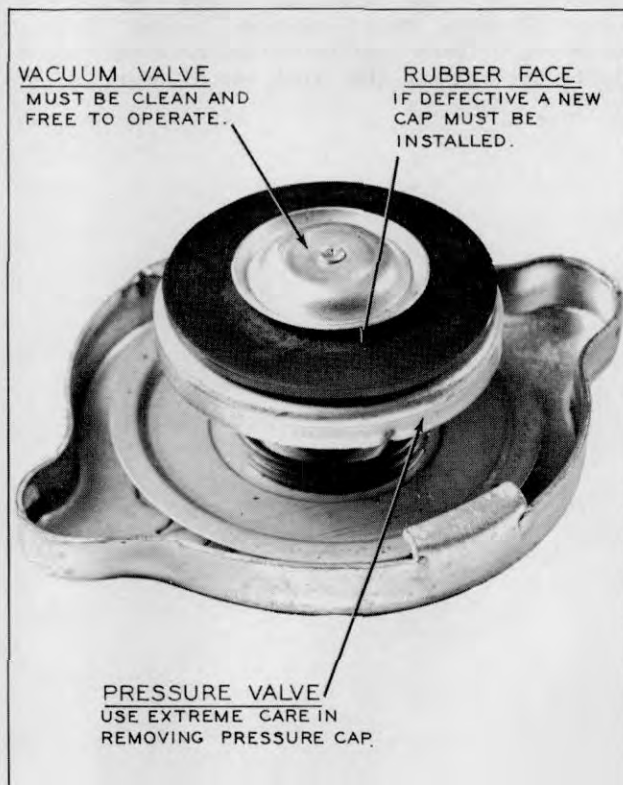

Plate 6459. Pressure Cap Gasket, Valve and Valve Gasket

**NOTE**

EXHAUST GAS LEAKAGE BETWEEN CYLINDER HEAD AND GASKET ALSO RESULTS IN CORROSION. IF EXHAUST GAS DISCHARGES INTO COOLANT, THE COOLANT AND THE GAS COMBINE TO FORM A VARIETY OF ACIDS. IT IS THEREFORE IMPORTANT THAT CYLINDER HEAD STUD NUTS BE DRAWN DOWN TO SPECIFICATIONS AS INSTRUCTED IN "ENGINE TUNE-UP".

LUBRICATION AND PREVENTIVE MAINTENANCE

Using a washing soda solution, flush cooling system in the following manner:

1. Drain system.
2. Replace half of volume with fresh water. Refer to Specifications for capacity.
3. Boil other half of volume and add washing soda until no more will dissolve.
4. Add hot soda solution to cooling system (fill up).
5. Operate engine normally for 24 hours.
6. Drain, flush, refill with clean water to which a soluble oil has been added in a proportion of 1 ounce per gallon of water.

Maintaining the cooling system efficiency is important, as engine temperatures must be brought up to and maintained within satisfactory range

for efficient operation; however, must be kept from overheating, in order to prevent damage to valves, pistons and bearings. Continued overheating may cause internal damage, while continuously low operating temperature wastes fuel, increases engine wear and causes oil sludge and corrosion of engine parts.

Overcooling may be caused by operating conditions such as excessive idling, low speeds and light loads during cold weather. Overheating may be caused by faulty thermostat, clogged radiator or an improperly adjusted fan belt.

**CAUTION**

NEVER POUR COLD WATER OR COLD ANTI-FREEZE INTO THE RADIATOR OF AN OVERHEATED ENGINE. ALLOW THE ENGINE TO COOL AND AVOID THE DANGER OF CRACKING THE CYLINDER HEAD OR BLOCK. KEEP ENGINE RUNNING WHILE ADDING WATER.

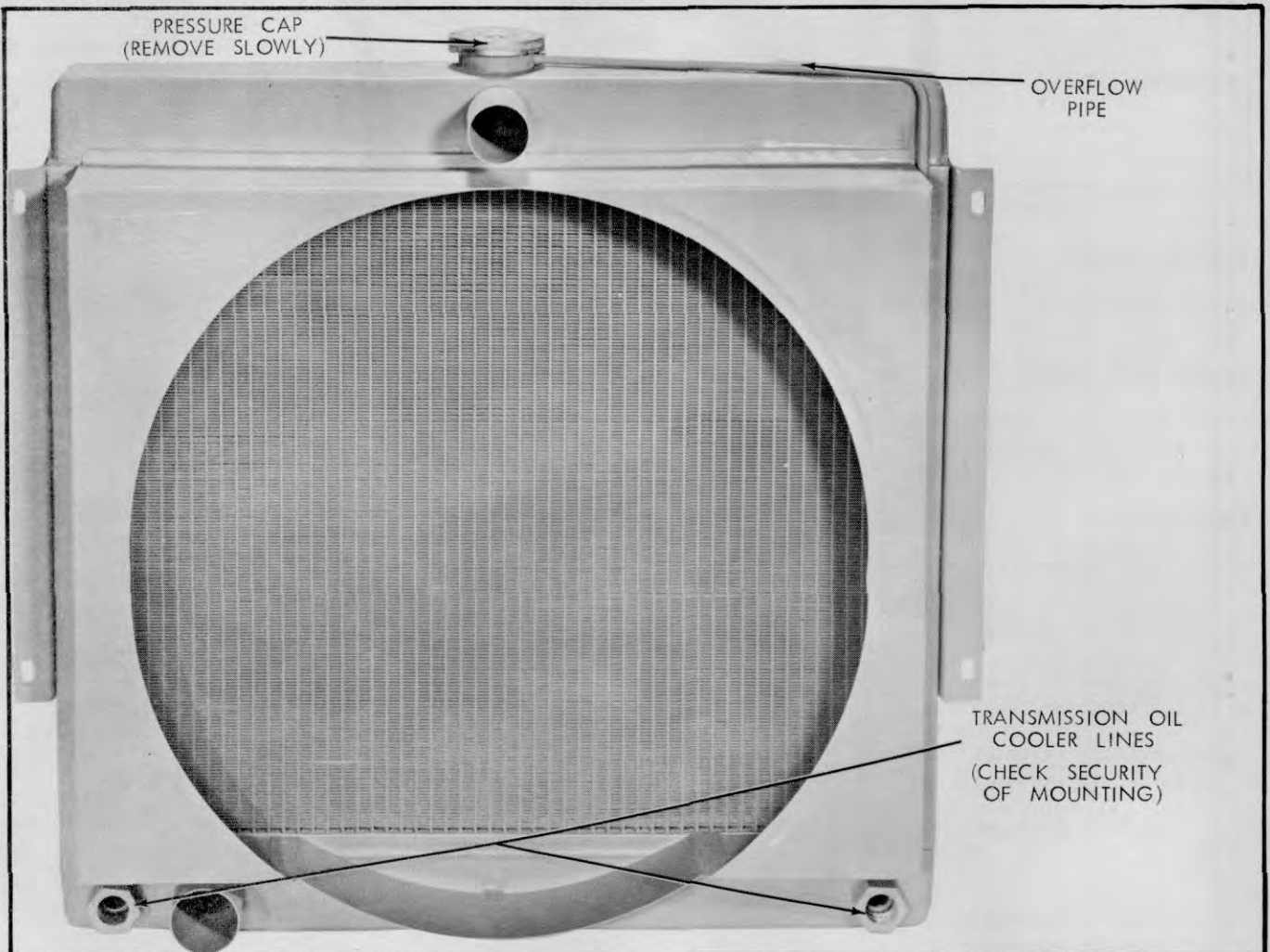

Plate 6460. Typical Radiator

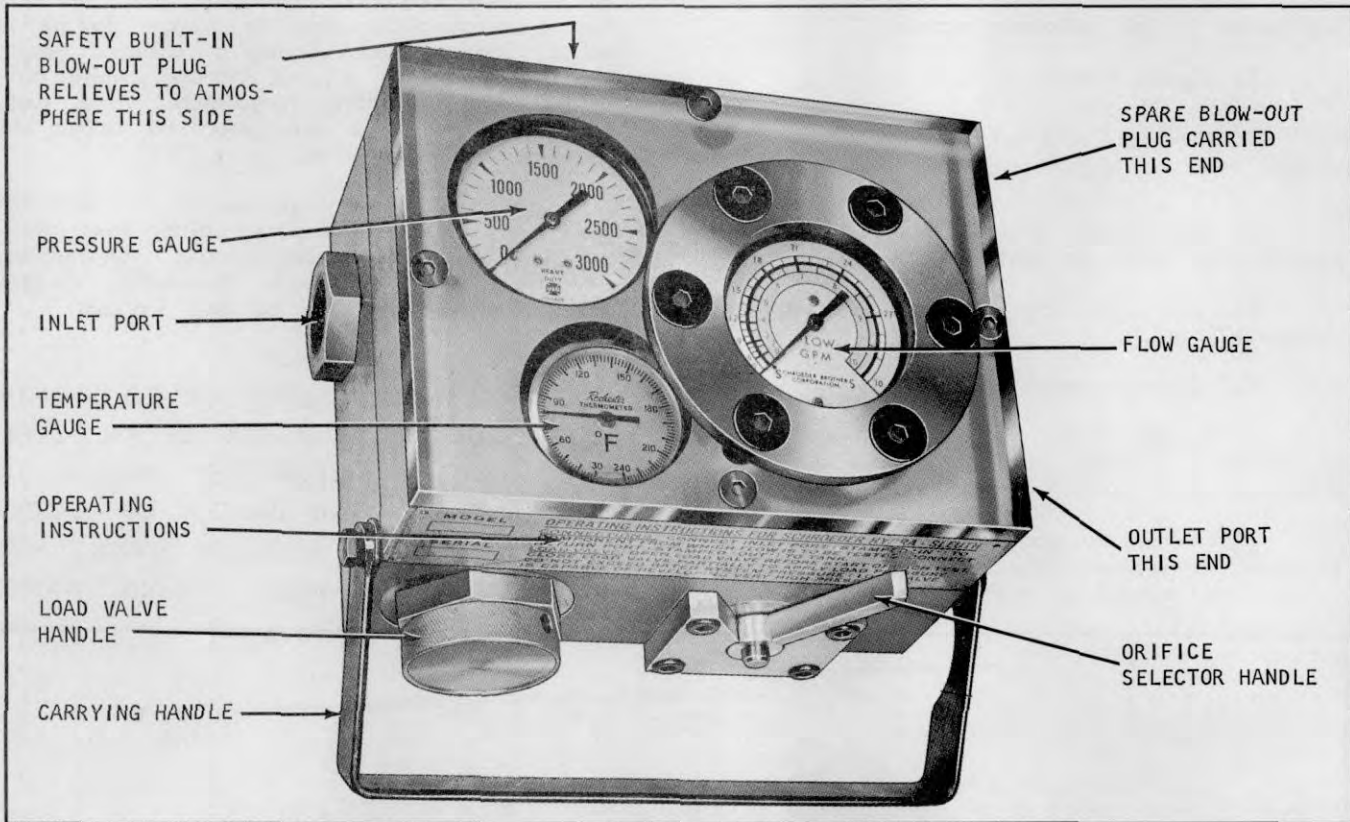

Plate 6747. Schroeder Hydraulic Circuit Tester CLARK PART NUMBER 1800060

PRESSURE GAUGE

Reads directly in pounds per square inch (PSI).

TEMPERATURE GAUGE

Reads directly in degrees Fahrenheit and indicates the temperature of the oil passing through the instrument.

FLOW GAUGE

Reads two scales in gallons per minute.

- 0 - 30 gallons
- 9 - 30 gallons

Read the scale that corresponds with the orifice selector position.

Turn orifice selector to the left (counter-clockwise) to read 10 gallon scale.

Turn orifice selector to the right (clockwise) to read 30 gallon scale.

You may switch from one scale to the other, while operating machine. Always start on 30 gallon scale.

LOAD VALVE

The load valve is a flow restrictor or shut off valve. Turning the valve to the right throttles flow through the Hydra-Sleuth, thus the operator may load a hydraulic pump or circuit to the desired test pressure, simulating work.

SAFETY PLUG

Located opposite the load valve this plug protects the Hydra-Sleuth and the tested system from pressures in excess of 3200 PSI. When pressure becomes higher the plug will rupture and dump oil to atmosphere.

HYDRAULIC FLUID

Unless marked to the contrary, the unit is for use with petroleum, hydraulic fluids.

HOW TO CONNECT THE PORTABLE TESTER

Using a 1/2" hose or larger, connect tester INLET PORT to the flow to be tested. Connect the tester outlet port to reservoir fill port, or system return line.

## LUBRICATION AND PREVENTIVE MAINTENANCE

HYDRA-SLEUTH ADJUSTMENTS BEFORE OPERATION

A. Depending on flow (GPM) to be checked choose proper orifice. (It is good practice to start always on 30 gallon scale.)

B. Fully open load valve by turning all the way to the left.

HYDRA-SLEUTH ADJUSTMENTS DURING OPERATION

1. Turn load valve to right to develop test pressures.

**CAUTION**

LOAD VALVE IS CAPABLE OF VERY HIGH PRESSURES.

A. Always start test with load valve fully open.

B. Do not exceed design pressure of system under test.

C. Keep load pressures within range of the Hydra-Sleuth pressure gauge.

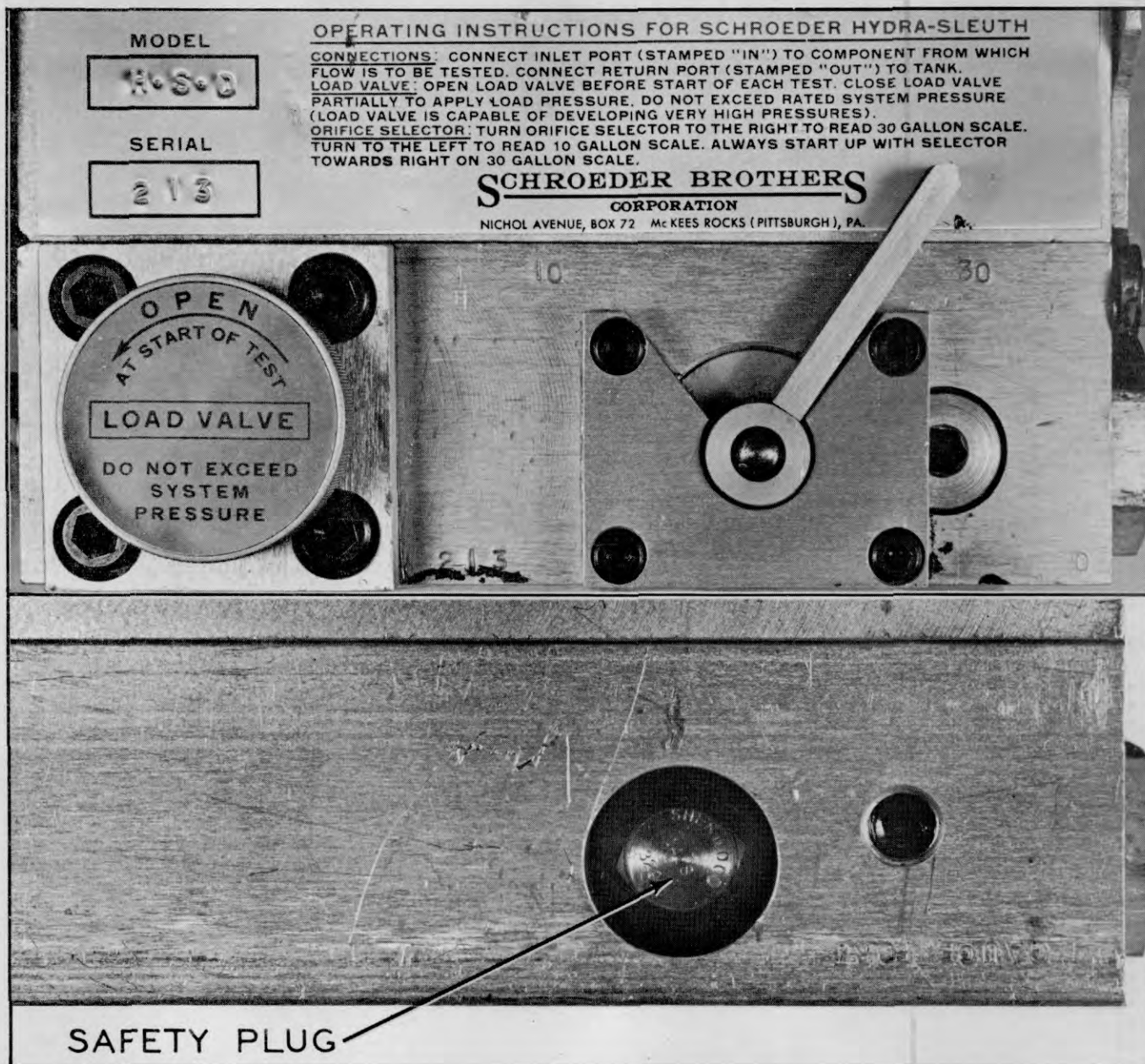

Plate 6748. Schroeder Hydraulic Circuit Tester

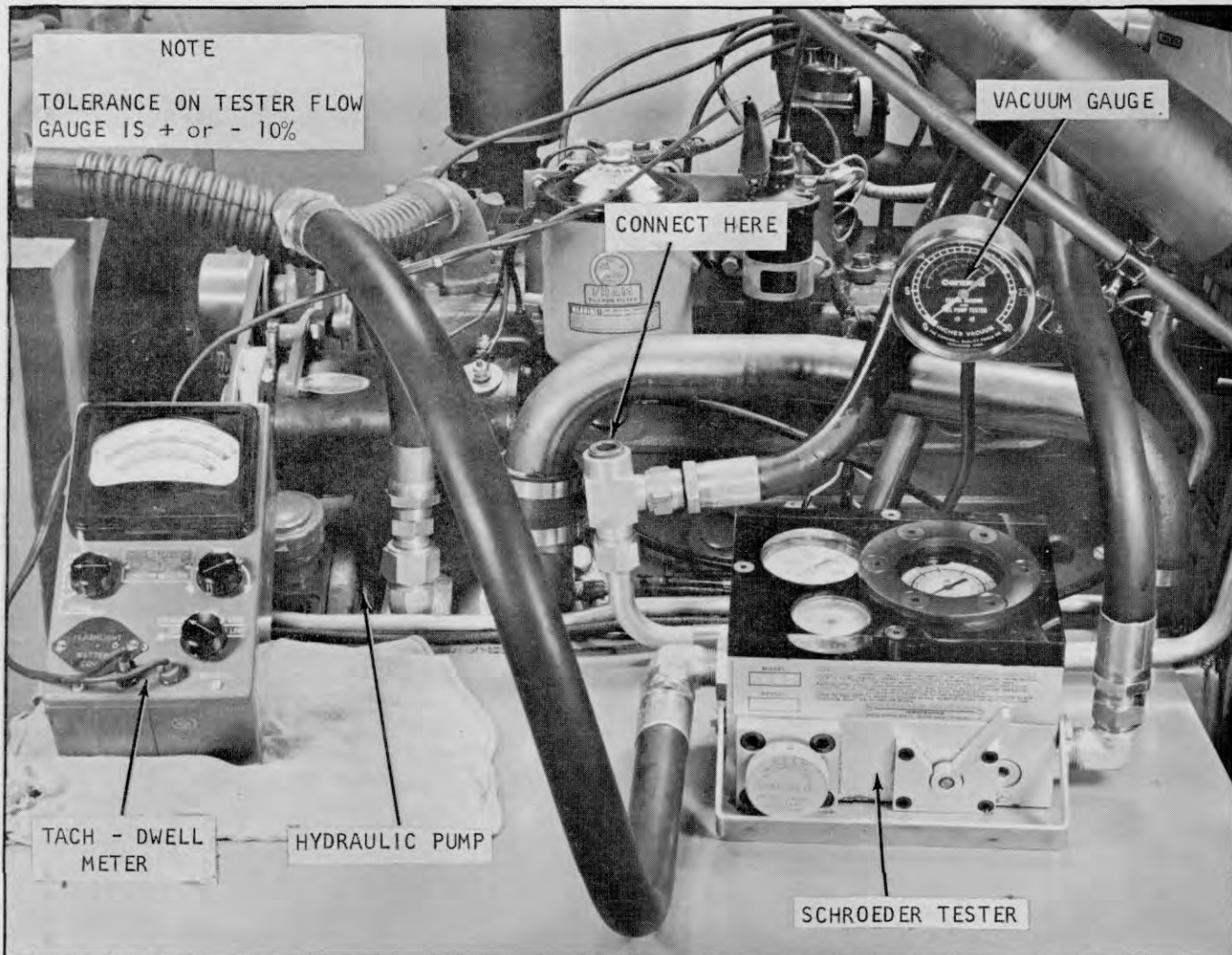

Plate 6749. Flowmeter Hookup

**HOOK UP FLOWMETER**

Install the high pressure hose onto the pump as shown, see Plate 6749. Attach the return line hose as shown in Plate 6749.

**TESTING PUMP OUTPUT**

1. Start the Tractor engine, and set speed to the exact R.P.M. stated in the chart below.

2. To heat up oil, apply the load valve until pressure reaches 1000 P.S.I. CAUTION: APPLY PRESSURE GRADUALLY. FAILURE TO OBSERVE THIS PRECAUTION COULD RESULT IN "BLOWING-OUT" THE FLOWMETER RELIEF PLUG.

3. After the oil has come up to test temperature (120°F.) and the flow gauge needle is stabilized, apply the load valve GRADUALLY until desired pressure is achieved. Then stabilize the pressure needle. NOTE: IT WILL BE NECESSARY TO INCREASE TRACTOR SPEED SLIGHTLY AS PUMP MUST BE TESTED UNDER LOAD (AT SPECIFIED R.P.M.)

CAUTION: LIMIT TIME THE LOAD VALVE IS SET FOR A READING OF 2000 P.S.I. TO 30 SECONDS EXTENDED PERIOD OF TIME WITH MAXIMUM READING COULD CAUSE DAMAGE.

4. Read the flow gauge. It should read reasonably close to the specifications for a new pump as listed below.

ENGINE R.P.M.	P.S.I.	G.P.M.
2250	2000	17





INDUSTRIAL TRUCK DIVISION



OPERATORS

MAINTENANCE

PARTS

MANUAL

FOR

CY-60

CLARK EQUIPMENT COMPANY

PUBLISHED BY

TECHNICAL SERVICE DEPARTMENT  
BATTI, CREB, WICHMAN, U.S.A.



# INDUSTRIAL TRUCK DIVISION



LUBRICATION AND PREVENTIVE MAINTENANCE

## TRANSMISSION STALL AND PRESSURE CHECKS

### Minimum Tools Required

- 1 - Pressure Gauge 0-250 PSI
- 1 - Tachometer

Before making transmission checks the machine should be steam cleaned. It is important that the radiator be clean externally and internally so that it is capable of maintaining proper cooling for the engine and transmission.

1. Operate engine 3 to 4 minutes to fully charge the transmission plumbing and the torque converter. With the engine operating at idle and the transmission in "Neutral" check the fluid level on the dipstick. Fill if necessary to the "Cold Full" mark or the "Hot Full" mark, depending upon the temperature of the transmission. Use Type "A", Suffix "A" Automatic Transmission Fluid, Clark Part #879803. Container must be imprinted AQ-ATF.

2. Check brake pedal free travel.

The hydraulic *inching* (brake) pedal should contact the floorboard when in the released (up) position. Refer to page 100H-302 for explanatory illustrations on Pedal Free Travel.

3. With a tachometer, check engine for governed speed at full throttle. The unloaded engine RPM should be set at 2400.

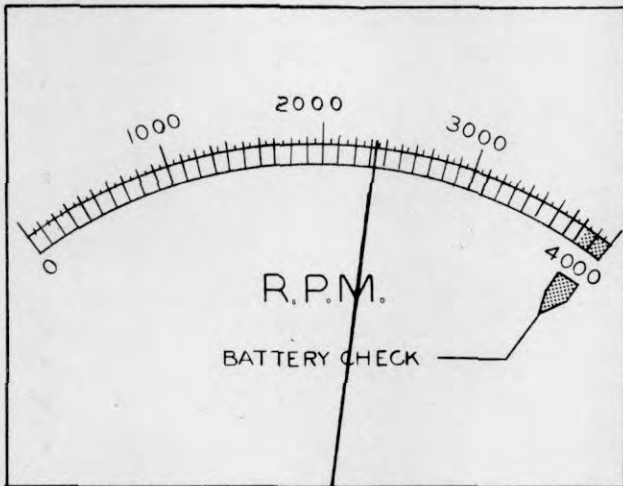

Plate 6683. Engine RPM (no load)

4. Check governed engine speed with partial load. With engine at full throttle and upright in full backward tilt, momentarily hold the tilt lever back to load the engine. With the engine loaded in this manner the approximate engine RPM should be 2200.

## NOTE

Engine must be properly tuned before making transmission stall checks.

## CAUTION

PROLONGED STALLING OF THE CONVERTER CAN CAUSE INTERNAL DAMAGE TO THE CONVERTER. STALL CONVERTER ONLY LONG ENOUGH TO ATTAIN THE PEAK RPM READING, (MAXIMUM 30 SECONDS).

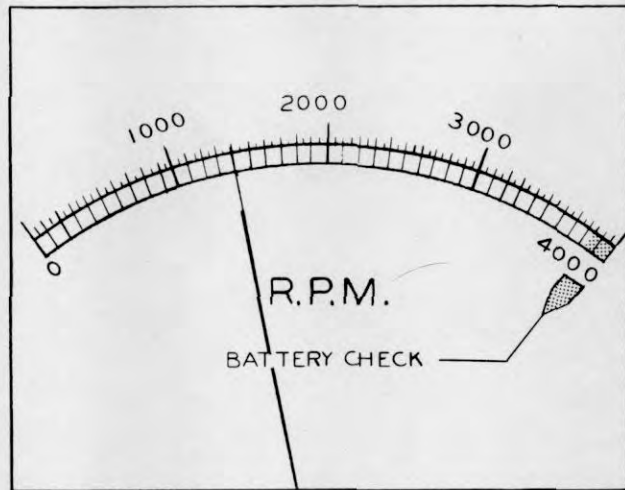

Plate 6684. Normal Engine Stall

5. With a capacity load on the forks, check for normal stall RPM by positioning machine against an immovable object. Place the machine in gear and accelerate engine to full throttle.

Normal Stall for F-227 Engine.....  
..... 1300 to 1400 RPM

WHEN APPLYING BRAKE HYDRAULIC PRESSURE  
92# ± 5 TO INCHING VALVE "F" AND "R"  
CHECKED INDIVIDUALLY MUST DROP OFF TO  
3# ± 2 P.S.I. MAX. WITH INCHING BREAK  
OFF POINT OF 55# ± 5

UNLESS OTHERWISE SPECIFIED

IMMERSE ALL OIL SEALS IN TYPE "A"  
TRANSMISSION FLUID BEFORE ASSEMBLY

IMMERSE IN UCON-1145 FLUID BEFORE ASSEM.

OIL ALL "O" RINGS BEFORE ASSEMBLY

TIGHTEN ALL CAP SCREWS 20-25 FT. LBS. TORQUE

OIL FLOW TO CONTROL FROM FILTER  
5-7 GALLONS AT 1300 RPM ENGINE  
8-11 GALLONS AT 2000 RPM ENGINE  
TO BE TESTED WITH 200° F. OIL  
LEAKAGE-WITH F & R IN NEUTRAL  
& H OR L ENGAGED. LEAKAGE MUST  
NOT EXCEED .2 GAL.,

CONV. PRESS. 60 PSI AT  
1300 RPM. NOT TO EXCEED  
75 PSI AT 2200 RPM  
ENGINE.

NEUTRAL SWITCH (12 VOLTS)  
NEUTRAL-SWITCH CLOSED  
FOR. & REV.-SWITCH OPEN  
NEUTRAL START SWITCH TEST  
SEE NOTE

OIL PRESSURE CHECK  
AT 1300 RPM ENGINE  
120 LBS MIN-135 LBS MAX

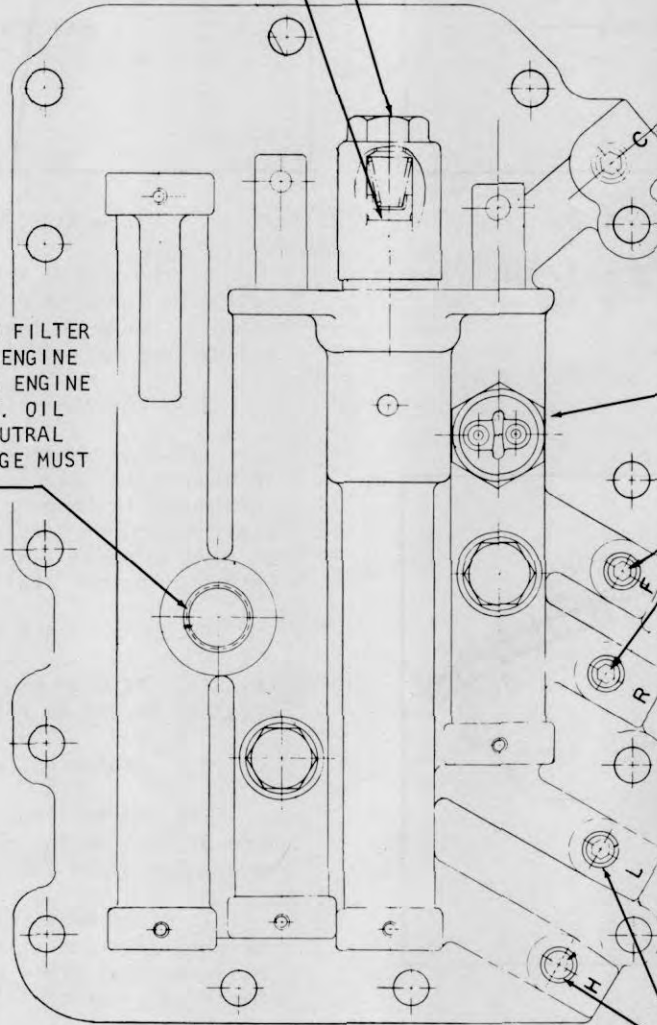

**NOTE**

**NEUTRAL START SWITCH TEST**

- 1-WIRE SWITCH INTO TEST STAND LIGHT CIRCUIT
- 2-WITH ENGINE RUNNING & TRANSMISSION IN LOW  
FOR., NUDGE CONTROL FOR. & REV. SPOOL  
SLOWLY TOWARD NEUTRAL. IF SWITCH DOES NOT  
MAKE CONTACT REPEAT STARTING IN LOW REV.  
IF IN EITHER TEST CONTACT IS MADE WHEN NOT  
IN DEAD NEUTRAL, SWITCH IS TO BE SHIMED,  
TILL TEST SHOWS PROPER FUNCTION.

**OIL PRESSURE CHECK**

- AT 1300 RPM ENGINE-150 LBS. MIN.
- AT 2200 RPM ENGINE-165 LBS. MAX.

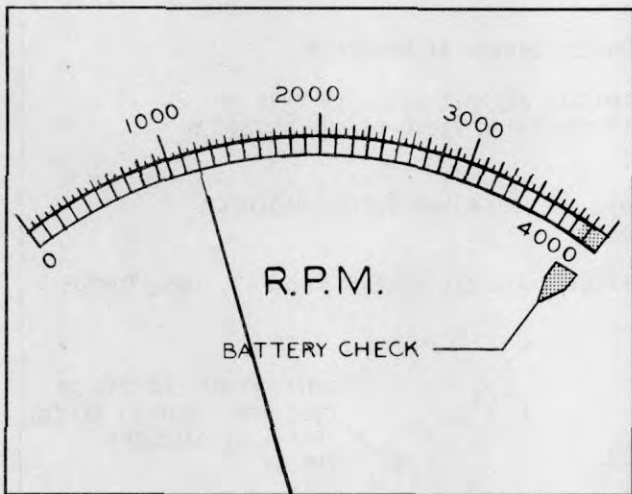

Plate 7327. Interim Stall

If the engine stall R.P.M. is within the following range -- loss of engine power is indicated.

F-227 Engine 1000 to 1300 R.P.M.

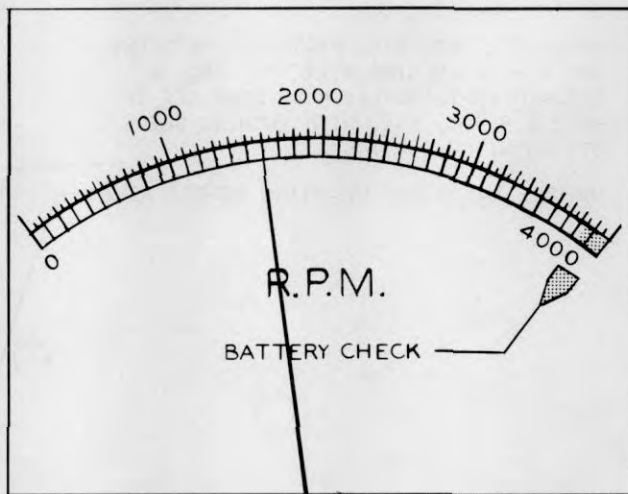

Plate 7328. High Engine Stall

If the engine stall R.P.M. is within the following range -- either slippage of the selector packs or low oil pressure (converter fin damage) is indicated.

F-227 Engine 1450 R.P.M. and above.

If stall readings are normal, check inching valve operation by operating the inching or brake pedal. This will vary stall R.P.M. by varying pressure on forward or reverse packs. This reading should vary from normal stall speed to high R.P.M.

**N O T E**

ANY STALL READING OTHER THAN NORMAL, MAKE PRESSURE CHECKS AS FOLLOWS.

**Transmission Pressure Checks**

The transmission pressure checks are made at the testing ports of the control cover. See plate 7326.

1. Place heavy blocking under the upright rails and tilt upright forward until vertical. This will allow the drive wheels to clear the floor.

2. Install a 250 P.S.I. pressure gauge at one of the testing ports (whichever direction or range of speed being tested.) With shift lever in related position the pressure should be within the range as specified on Plate 7326.

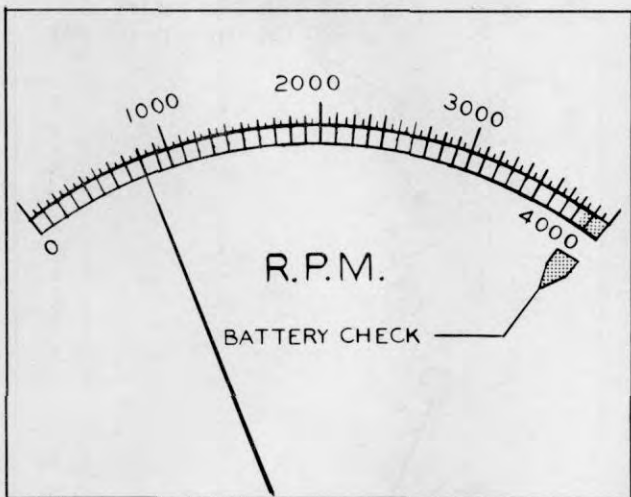

Plate 6686. Low Engine Stall

If the engine stall R.P.M. is within the following range -- converter malfunction or a faulty stator support shaft is indicated.

F-227 Engine 650 to 900 R.P.M.

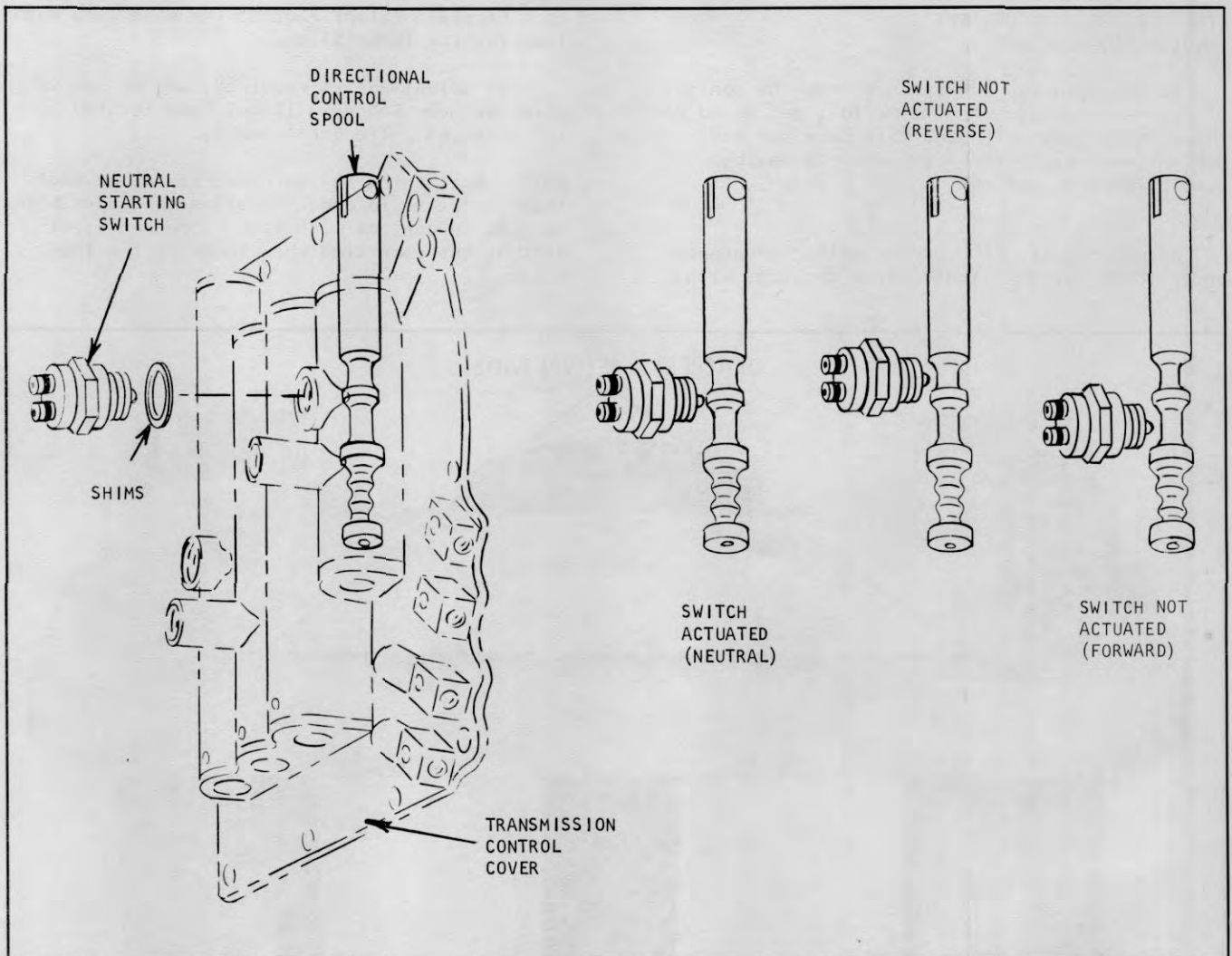

Plate 7300. Neutral Starting Switch

**NEUTRAL STARTING SWITCH**

The neutral starting switch should be adjusted so that machine will not start except when the transmission control is in the (dead) neutral position.

**ADJUSTMENT CHECK**

1. With driver's seat occupied and transmission in gear hold starting switch in actuated position and gently move shift lever towards neutral position.

2. If engine does not start, repeat adjustment operation in opposite direction.

3. If engine starts, coming from either direction on the shift lever prior to reaching neutral, switch should be adjusted by means of shims underneath the switch until engine will not start unless it is in (dead) neutral; that is, vehicle will not move regardless of shift lever position during the starting cycle.

## LUBRICATION AND PREVENTIVE MAINTENANCE

LIFT CARRIAGE AND UPRIGHT  
ROLLER ADJUSTMENTS

To maintain top performance from the upright it may be necessary, from time to time, to adjust the rollers located on the Lift Carriage and Upright Assembly. These adjustments may be accomplished as follows:

Before checking for proper roller clearance, check to be sure the Inner Slide contacts with

both Fabreeka (Stop) Pads at the same time when lowering the Inner Slide.

If adjustment is required, add or remove shims between Fabreeka (Stop) Pads located on the Outer Rail Tie Bar Assembly.

NOTE: More shims may be required on one side than the other in order to allow the Inner Slide to come in contact with both Fabreeka (Stop) Pads at the same time when lowering the Inner Slide.

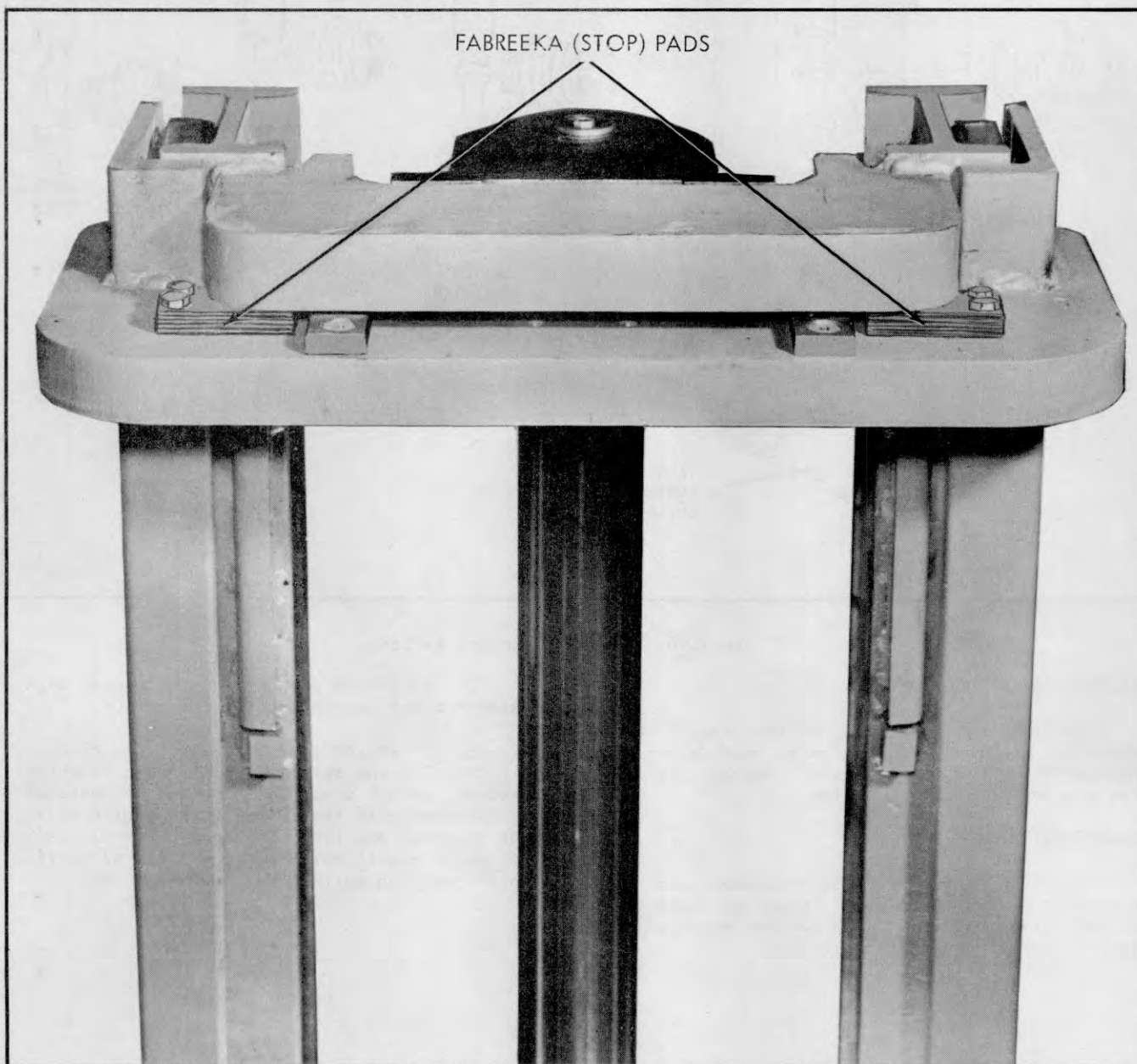

Plate 6619. Inner Slide Must Contact Both Fabreeka (Stop) Pads  
At The Same Time When Lowering Inner Slide

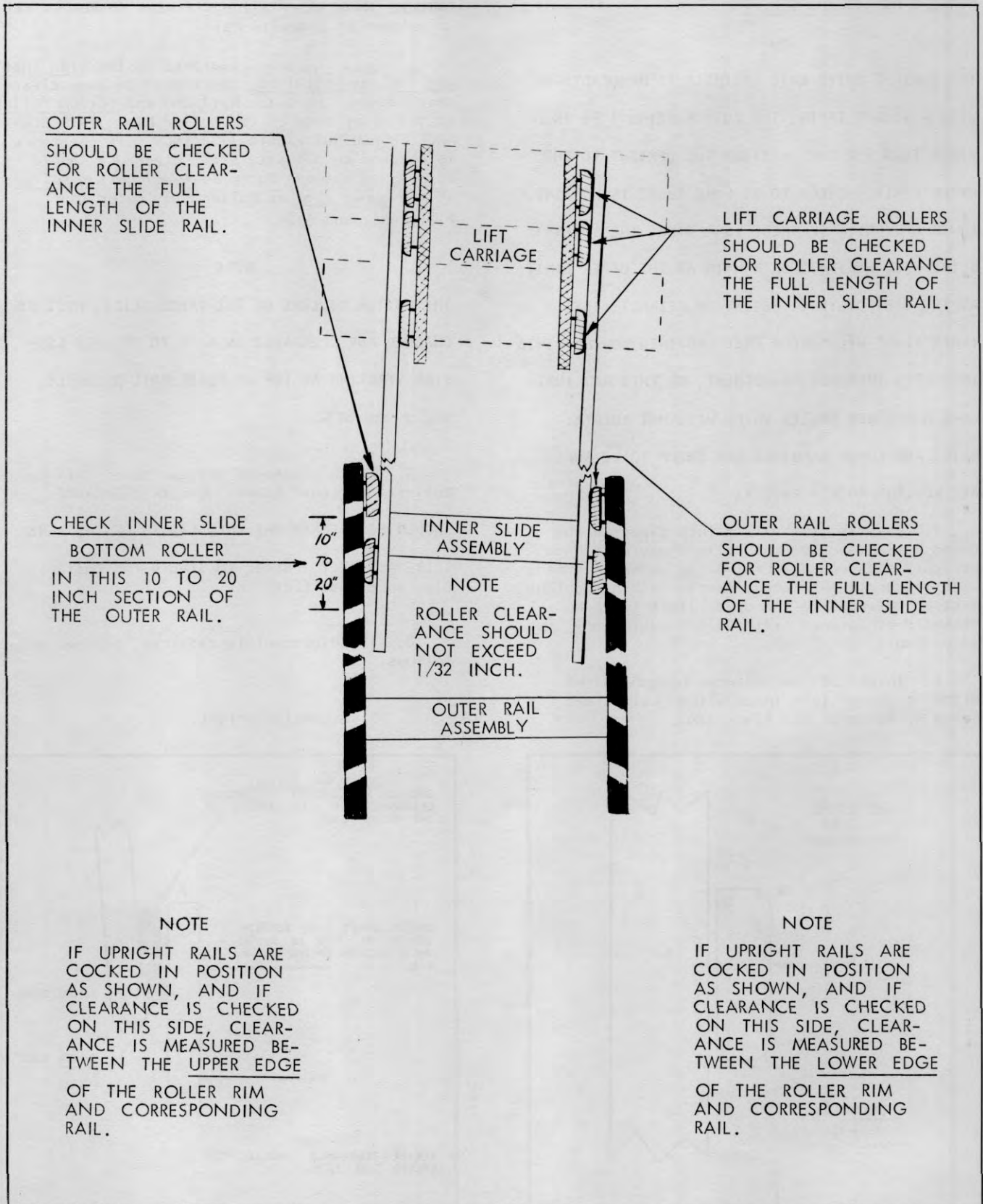

Plate 6891. Roller Adjustments

LUBRICATION AND PREVENTIVE MAINTENANCE

UPRIGHT ROLLER ADJUSTMENTS.

NOTE

THE UPRIGHT OUTER RAIL ASSEMBLY IS MANUFACTURED WITH A SLIGHT TAPER, THE BOTTOM BEING 1/16 INCH WIDER THAN THE TOP. EXTEND THE UPRIGHT TO THE UPPER LIMIT. CHECK TO BE SURE THERE IS NO BIND. LOWER UPRIGHT. IF THERE IS A BIND, THE INNER SLIDE WILL HESITATE OR REMAIN AT THE UPPER LIMIT. AS THE LIFT CYLINDER BEGINS TO RETRACT, THE INNER SLIDE WILL BREAK FREE AND THEN LOWER. THIS INDICATES IMPROPER ADJUSTMENT, OR THIS MAY INDICATE A DAMAGED ROLLER WHICH WILL NOT ROTATE. RAISE AND LOWER CARRIAGE AND CHECK TO BE SURE ALL ROLLERS ROTATE FREELY.

1. Because of the 1/16 inch taper in the Outer Rail Assembly, the rollers may bind when upright is extended if roller adjustment is made with the upright lowered; therefore, the upright must be extended to the upper limit (with no backward or forward tilt) before making any adjustments.

2. Insert pry bar between bottom end of either right or left Inner Slide (Rail), and Outer Rail, refer to Plate 6891.

3. Move Inner Slide sideways to remove all clearance at opposite rail.

4. When checking clearance on the side that pry bar was installed, there must be some clearance between the Outer Rail and the bottom roller at the lower edge of the Roller Rim. THIS CLEARANCE SHOULD NOT EXCEED 1/32 INCH. If clearance is checked on opposite side, clearance should be checked between Outer Rail and bottom roller at the upper edge of Roller Rim, refer to Plate 6891 and 6325.

NOTE

THE BOTTOM ROLLERS OF THE INNER SLIDE, MUST BE CHECKED FOR CLEARANCE IN A 10 TO 20 INCH SECTION STARTING AT TOP OF OUTER RAIL ASSEMBLY, SEE Plate 6572.

5. Check clearance between Outer Rail Upper Rollers and Inner Slide. ROLLER CLEARANCE SHOULD BE CHECKED THE FULL LENGTH OF THE INNER SLIDE ASSEMBLY. Refer to Step 4 for Roller Clearance Specifications.

6. If adjustment is required, proceed as follows:

7. Disassemble upright.

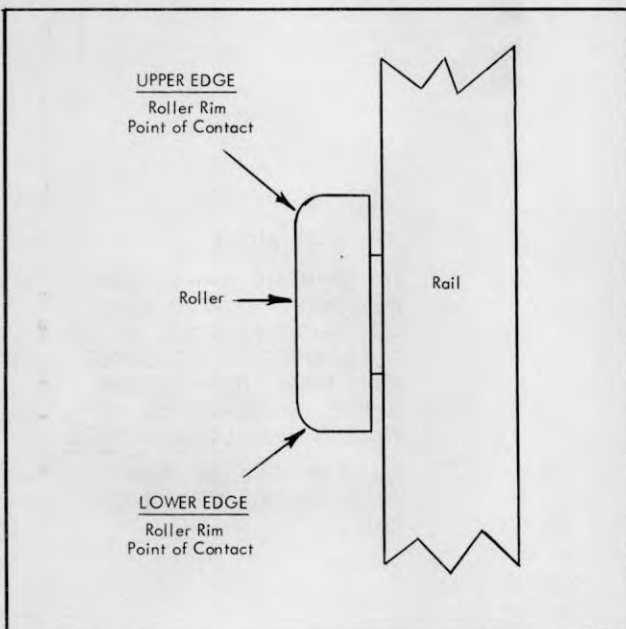

Plate 6325. Upright Roller

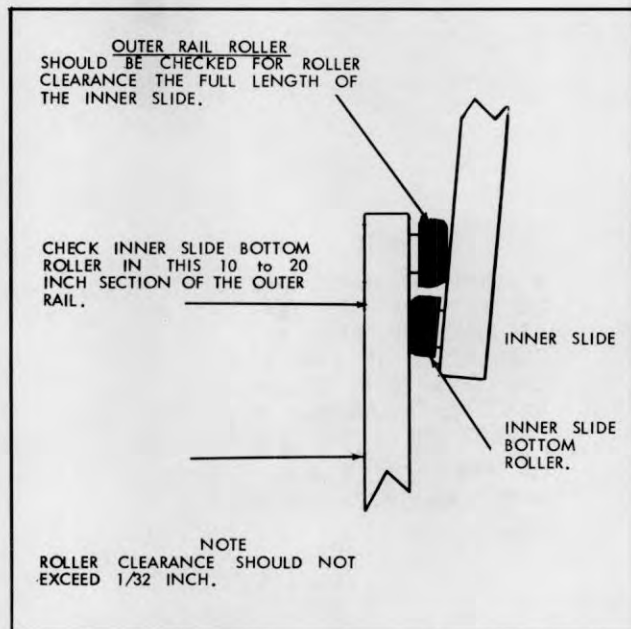

Plate 6572. Outer Rail Roller Clearance Check



## LUBRICATION AND PREVENTIVE MAINTENANCE

8. Remove rollers from shafts and add or remove shims to acquire the clearance previously stated.

## NOTE

THE ROLLER SHAFTS ARE WELDED TO THE RAIL ASSEMBLIES. TO REMOVE ROLLERS, MERELY PULL ROLLERS FREE OF ROLLER SHAFTS.

9. Reassembly upright.

10. Follow Steps 1 thru 5 and recheck clearance.

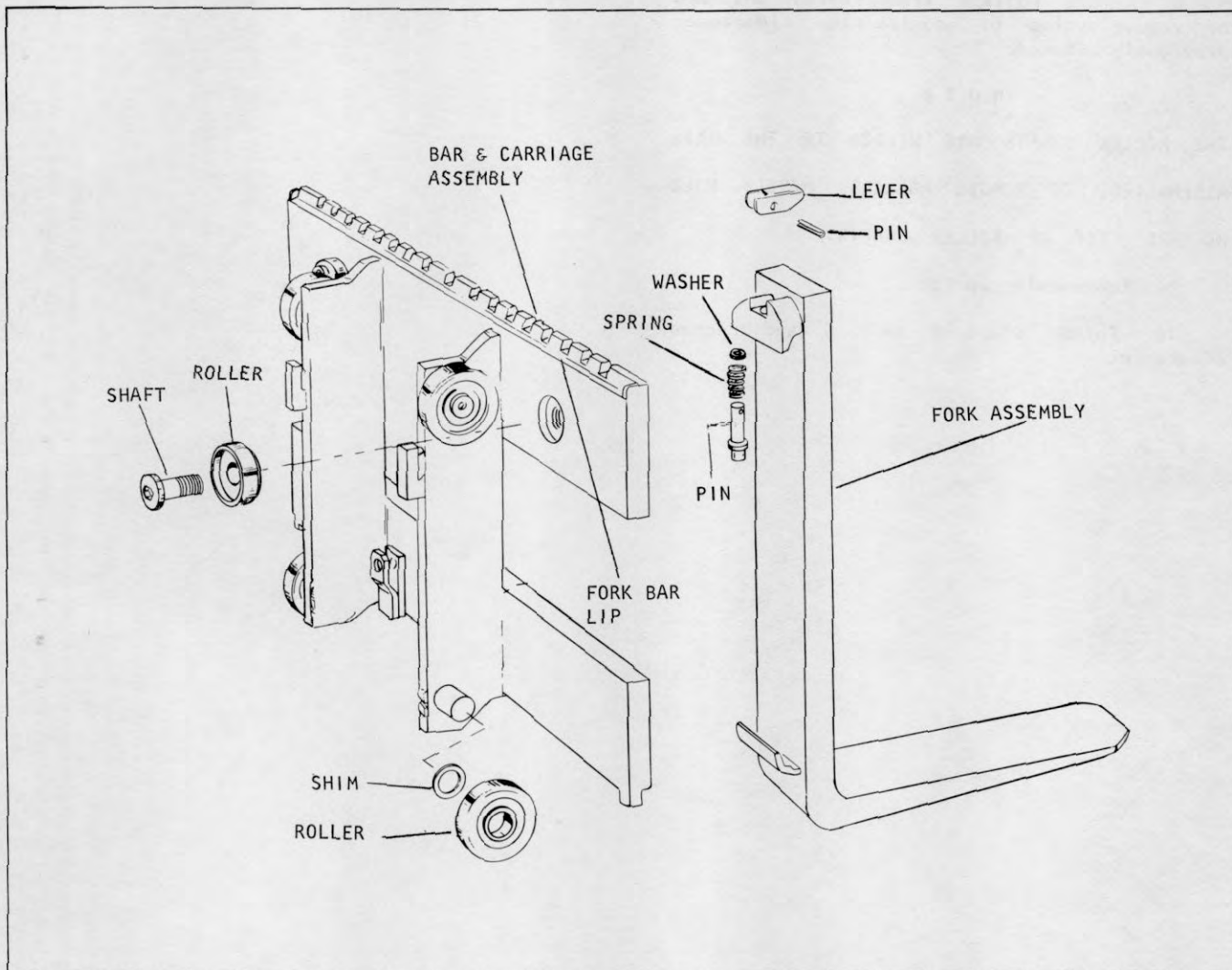

Plate 9483. Lift Carriage

LIFT CARRIAGE ROLLER ADJUSTMENTS

CARRIAGE MUST BE ADJUSTED SO IT IS HORIZONTAL AND CENTERED IN THE UPRIGHT FRAME. ROLLER CLEARANCE SHOULD BE CHECKED THE FULL LENGTH OF THE RAILS. ROLLERS SHOULD HAVE CLEARANCE OF NOT MORE THAN 1/32 INCH AT EACH SIDE.

LIFT CHAINS MUST BE ADJUSTED SO THAT UPPER FORK BAR LIP IS 22 7/8" FROM FLOOR.

TROUBLE SHOOTING GUIDE

ENGINE

TROUBLE	PROBABLE CAUSE	REMEDY
Starting motor will not crank engine.	Battery discharged	Recharge or replace battery.
	Battery cable terminals loose or corroded. Ignition Fuse blown.	Remove and clean, reinstall and tighten cables. Replace fuse.
	Starting motor drive gear jammed in flywheel teeth.	Loosen starting motor and free-up gear.
	Improper oil.	Change oil to proper grade.
	Battery cable terminal broken.	Replace cable.
	Poor starting switch contacts.	Replace switch.
Starting motor operates, but fails to crank engine when switch is engaged.	Faulty Neutral Starting Switch.	Replace Switch
	Starting motor gear does not engage flywheel.	Remove starting motor, and clean drive mechanism.
<u>Engine will not start.</u> No spark. Ammeter shows no discharge (Zero reading) with ignition switch "on".	Starting motor or drive gear defective.	Replace starting motor.
	Ignition switch partly "on".	Turn switch "on" fully.
	Ignition switch defective.	Replace switch.
	Ignition primary wires or starting motor cables broken or connections loose.	Repair, or replace and tighten.
	Ignition coil primary winding open.	Replace coil.
	Distributor points dirty.	Clean and adjust points.
<u>Engine will not start.</u> Ammeter showing abnormal discharge with ignition switch "on".	Distributor points not closing.	Adjust or replace points.
	Loose or corroded ground, or battery cable connections.	Remove and clean, reinstall and tighten cables.
	Defective condenser.	Replace condenser
	Short-circuited or burned distributor cap or rotor.	Replace parts.
	Short-circuited wire between ammeter and ignition switch.	Repair or replace wire.
	Short-circuited primary winding in ignition coil.	Replace coil.
Ammeter showing abnormal discharge with ignition switch "on".	Distributor points not opening.	Clean or replace, and adjust points.
	Distributor points pitted or burned.	Clean or replace, and adjust points.
	Distributor condenser weak.	Replace condenser.
	Ignition coil weak.	Replace coil.



# INDUSTRIAL TRUCK DIVISION



## TROUBLE SHOOTING GUIDE

### ENGINE (CONTINUED)

TROUBLE	PROBABLE CAUSE	REMEDY
<p><u>Engine will not start.</u> Weak spark (continued)</p>	<p>Primary wire connections loose.</p> <p>High-tension, spark plug wires, or distributor cap wet.</p> <p>High-tension, spark plug wires, or distributor cap damaged.</p> <p>Distributor cap or rotor burned or broken.</p> <p>Spark plug gap incorrect.</p> <p>Short-circuited secondary circuit in coil.</p>	<p>Tighten.</p> <p>Dry thoroughly.</p> <p>Replace defective parts.</p> <p>Replace defective parts.</p> <p>Reset Gaps.</p> <p>Replace coil.</p>
<p>Good spark.</p>	<p>Fuel tank empty.</p> <p>Dirt or water in carburetor, or float stuck.</p> <p>Carburetor and engine flooded by excessive use of choke.</p> <p>Fuel does not reach carburetor.</p> <p>Dirt in fuel lines or tank.</p> <p>Fuel line pinched.</p> <p>Ignition wires incorrectly installed in distributor cap.</p> <p>Ignition timing incorrect.</p> <p>Fuel Strainer Clogged.</p> <p>Fuel pump does not pump.</p> <p>Lack of engine compression.</p>	<p>Refill tank.</p> <p>Drain and clean carburetor</p> <p>Depress accelerator pedal fully, crank engine with starting motor when engine starts, reset throttle and leave choke control "in".</p> <p>Inspect for damaged or leaky lines or air leak into line between tank and fuel pump.</p> <p>Disconnect lines, drain tank, and blow out lines.</p> <p>Repair or replace line.</p> <p>Install wires correctly.</p> <p>Reset timing.</p> <p>Remove and clean strainer.</p> <p>Clean screen, replace pump if defective.</p> <p>Replace head gasket, Grind valves, replace valve spring, replace bad valve.</p>
<p>Backfiring.</p>	<p>Ignition out of time.</p> <p>Spark plug wires incorrectly installed distributor cap or at spark plugs.</p> <p>Distributor cap cracked or shorted</p> <p>Valve holding open.</p>	<p>Reset timing.</p> <p>Install wires correctly.</p> <p>Replace cap.</p> <p>Reset timing, replace valve springs. Adjust tappets.</p>

TRUBLE SHOOTING GUIDE

ENGINE (CONTINUED)

TROUBLE	PROBABLE CAUSE	REMEDY
Engine operates, but backfires and spits.	Improper ignition timing.	Reset timing.
	Spark plug wires incorrectly installed in distributor cap.	Install wires correctly.
	Dirt or water in carburetor.	Drain and clean carburetor.
	Carburetor improperly adjusted.	Clean and adjust carburetor.
	Carburetor float level low.	Reset Float Level
	Valve sticking or not seating properly, burned or pitted.	Regrind Valves
	Excessive carbon in cylinders.	Remove carbon from cylinders.
	Valve springs weak.	Replace Valve Springs
	Heat control valve not operating.	Free-up, and adjust valve.
	Fuel pump pressure low.	Clean screen; replace pump, if defective.
	Fuel strainer clogged.	Remove and clean strainer.
	Partly clogged or pinched fuel lines.	Clean and repair lines.
	Intake manifold leak.	Inspect gaskets and tighten manifold stud nuts.
Distributor cap cracked or shorted.	Replace cap.	
Engine stalls on idle.	Carburetor throttle valve closes too far, or idle mixture incorrect.	Adjust carburetor.
	Carburetor choke valve remains closed.	Free-up and lubricate valve.
	Dirt or water in idler passages of Carburetor.	Clean or replace carburetor.
	Air leak at intake manifold.	Inspect gaskets and tighten manifold stud nut.
	Heat control valve defective.	Free-up and adjust valve.
	Spark plugs defective, gaps incorrect.	Clean or replace spark plugs, set gap clearance.
	Ignition timing early.	Reset timing.
	Low compression.	Tighten intake manifold. Adjust valve.
	Water leak in cylinder head or head gasket.	Replace gasket.



# INDUSTRIAL TRUCK DIVISION



## TROUBLE SHOOTING GUIDE

### ENGINE (CONTINUED)

TROUBLE	PROBABLE CAUSE	REMEDY
Engine misfires on one or more cylinders.	Dirty spark plugs. Spark plug gap incorrect. Cracked spark plug porcelain. Spark plug wires grounded. Spark plug wires incorrectly installed in cap or at spark plugs. Distributor cap or rotor burned or broken. Valve tappet holding valve open. Low engine compression. Leaky cylinder head gasket. Cracked cylinder block, broken valve tappet or tappet screw.	Clean, adjust, or replace plugs. Reset gap. Replace spark plug. Replace wires. Install wires incorrectly. Replace defective parts. Adjust tappets Adjust tappets, Retime engine, Replace rings. Replace gasket. Replace defective or broken parts.
Engine does not idle properly.	Ignition timing. Dirty spark plugs, or gaps too close.	Reset timing. Clean and adjust spark plugs.
Engine misses at high speeds.	Ignition coil or condenser weak. Distributor points sticking, dirty or improperly adjusted. Distributor rotor or cap cracked or burned. Leaky cylinder head gaskets. Uneven cylinder compression. High-tension or spark plug wires leaky, cracked insulation. Carburetor choke not adjusted. Carburetor accelerating pump system defective, dirt in metering jets or float level incorrect. Fuel pump defective, causing lack of fuel. Air cleaner dirty. Heat control valve defective	Replace defective parts. Clean, adjust, or replace points. Replace defective parts. Replace gaskets. Adjust tappets or timing. Replace defective parts. Adjust choke. Replace defective parts, Clean carburetor, reset float level. Clean screen, replace defective pump. Clean complete air cleaner and refill oil cup. Free-up and adjust.

ENGINE (CONTINUED)

TROUBLE	PROBABLE CAUSE	REMEDY
Engine misses at high speeds. (Continued)	<p>Valves sticking, weak or broken valve springs.</p> <p>Fuel strainer clogged.</p> <p>Weak distributor bracket arm spring.</p> <p>Excessive play in distributor shaft bearing.</p> <p>Spark plugs defective, dirty or gap incorrectly set.</p>	<p>Free up valves, replace valve springs.</p> <p>Remove and clean strainer.</p> <p>Replace point set.</p> <p>Replace distributor.</p> <p>Clean, adjust or replace spark plugs.</p>
Engine pings (Spark Knock.)	<p>Ignition timing early.</p> <p>Distributor automatic spark advance stuck in advance position, or spring broken.</p> <p>Excessive carbon deposits in cylinders.</p> <p>Incorrect fuel.</p>	<p>Reset timing.</p> <p>Replace distributor.</p> <p>Remove cylinder head and clean.</p> <p>Drain, use correct fuel.</p>
Engine lacks power.	<p>Ignition timing late.</p> <p>Incorrect fuel.</p> <p>Leaky cylinder head gasket.</p> <p>Excessive carbon formation.</p> <p>Engine runs cold.</p> <p>Insufficient oil, or improper grade oil.</p> <p>Oil system failure.</p> <p>Air Cleaner dirty.</p> <p>Spark plug gaps too wide.</p> <p>Choke valve partially closed, or throttle does not open fully.</p> <p>Manifold heat control inoperative.</p> <p>Exhaust pipe, muffler or tail pipe obstructed.</p> <p>Low compression, broken valve spring, sticking valves.</p>	<p>Reset timing.</p> <p>Use correct fuel.</p> <p>Replace gasket.</p> <p>Remove cylinder head, and clean cylinder head, piston heads, cylinder block, and valves.</p> <p>Test thermostat; in cold weather, cover radiator.</p> <p>Lubricate in accordance with lubrication section.</p> <p>Fill crankcase to prescribed level, check oil pressure.</p> <p>Clean complete air cleaner, change oil in cup.</p> <p>Reset gaps.</p> <p>Adjust valve or throttle.</p> <p>Free-up and adjust control.</p> <p>Service or replace obstructed parts.</p> <p>Replace valves or springs, Free up valves.</p>



# INDUSTRIAL TRUCK DIVISION



## TROUBLE SHOOTING GUIDE

ENGINE (CONTINUED)

TROUBLE	PROBABLE CAUSE	REMEDY
Engine lacks power. (Continued)	Improper tappet adjustment. Lack of fuel.	Adjust Tappets. Clean filter, inspect fuel pump, inspect carburetor for water or dirt and clean if necessary.
Engine overheats.	Cooling system deficient. Water low, air flow through radiator core restricted. Clogged radiator core (Clogged internally). Cylinder head gasket leaking. Radiator or water pump leaking. Damaged or deteriorated hose or fan belt. Loose fan belt. Cylinder block or head leaking. Ignition timing incorrect. Damaged muffler, bent or clogged exhaust pipe. Excessive carbon in cylinders. Insufficient oil, or improper grade. Air Cleaner restricted. Inoperative thermostat. Water pump impeller broken. Poor compression. Valve timing incorrect.	Clean radiator core from engine side with compressed air or water, or fill radiator to proper level. Clean by flushing radiator. Tighten cylinder head stud nuts and/or replace gasket. Repair or replace defective parts. Replace defective parts. Adjust fan tension. Replace block or head. Reset timing. Service or replace defective parts. Remove cylinder head, and clean cylinder head, piston heads cylinder block, and valves. Refer to lubrication Instructions. Clean complete change oil in cup. Replace thermostat and gasket Replace pump. Check ignition timing. Reset timing.
High fuel consumption.	High engine speeds (Excessive driving in lower gear range). Air cleaner clogged. Carburetor float level too high, accelerating pump not properly adjusted. Fuel line leaks.	Correct driving practice. Clean complete air cleaner and change oil in cup. Reset float level, overhaul carburetor pump. Correct leaks, replace lines.



ENGINE (CONTINUED)

TROUBLE	PROBABLE CAUSE	REMEDY
High fuel consumption. (Continued)	<p>Overheated engine.</p> <p>Carburetor parts worn or broken.</p> <p>Fuel pump pressure too high, or leaky diaphragm.</p> <p>Engine running cold.</p> <p>Ignition incorrectly timed.</p> <p>Spark advance stuck.</p> <p>Leaking fuel pump bowl gasket.</p> <p>Low compression.</p> <p>Carburetor controls sticking.</p> <p>Engine idles too fast.</p> <p>Spark plugs dirty.</p> <p>Weak coil or condenser.</p> <p>Clogged muffler, or bent exhaust pipe.</p> <p>Loose engine mounts, permitting engine to shake and raise fuel level in carburetor.</p>	<p>See "Engine overheats".</p> <p>Replace fuel carburetor.</p> <p>Replace fuel pump.</p> <p>Inspect thermostat, cover radiator in winter.</p> <p>Reset timing.</p> <p>Replace distributor.</p> <p>Replace gasket.</p> <p>Check timing, Rebuild Engine.</p> <p>Free-up and lubricate controls.</p> <p>Adjust carburetor throttle stop screw.</p> <p>Clean or replace spark plugs.</p> <p>Replace coil or condenser.</p> <p>Service or replace defective parts.</p> <p>Tighten; if damaged, replace defective mounts.</p>
High oil consumption	<p>High engine speeds, or excessive driving in low gear range.</p> <p>Oil leaks.</p> <p>Improper grade oil, or diluted oil.</p> <p>Overheating of engine causing thinning of oil.</p> <p>Oil filter clogged.</p> <p>Defective piston or rings, excessive side clearance of intake valves in guides, cylinder bores worn (scored, out-of-round, tapered); excessive bearing clearance, misaligned connecting rods.</p>	<p>Correct driving practice.</p> <p>Replace leaking gaskets.</p> <p>Use new oil of proper grade.</p> <p>See "Engine overheats".</p> <p>Clean filter case thoroughly and replace element.</p> <p>Replace worn parts.</p>



# INDUSTRIAL TRUCK DIVISION



## TROUBLE SHOOTING GUIDE

### ENGINE (CONTINUED)

TROUBLE	PROBABLE CAUSE	REMEDY
Low oil pressure.	<p>Insufficient oil supply.</p> <p>Improper grade of oil, or diluted oil foaming at high speed.</p> <p>Oil too heavy (Funneling in cold weather).</p> <p>Oil pump screen clogged.</p> <p>Oil leaks.</p> <p>Faulty oil pump, pressure regulator valve stuck or improperly adjusted, or spring broken.</p>	<p>Fill crankcase to prescribed level.</p> <p>Change oil, inspect crankcase ventilator inspect for water in oil.</p> <p>Change to proper grade oil. (Refer to Lubrication Instructions.</p> <p>Remove oil pan and clean pump screen.</p> <p>Replace gaskets or seals.</p> <p>Replace worn parts.</p>
Defective valves.	<p>Incorrect tappet adjustment.</p>	<p>Adjust tappets.</p>
Abnormal engine noises.	<p>Loose fan, fan pulley or belt, heat control valve.</p> <p>Leaking intake or exhaust manifold or gaskets, cylinder head gasket, or spark plugs.</p> <p>Overheated engine, clogged exhaust system</p>	<p>Tighten or correct conditions as required.</p> <p>Tighten loose components or replace defective gaskets.</p> <p>Remove obstruction from exhaust system. Inspect for further serviceability.</p>
Poor compression.	<p>Incorrect tappet adjustment.</p> <p>Leaking, sticking, or burned valves; sticking tappets; valve spring weak or broken; valve stems and guides worn; piston ring grooves worn or rings worn, broken, or stuck; cylinder bores scored or worn.</p>	<p>Adjust tappets.</p> <p>Replace worn, Broken, or Defective parts.</p>

TROUBLE SHOOTING GUIDE

FUEL SYSTEM

TROUBLE	PROBABLE CAUSE	REMEDY
Fuel does not reach carburetor	No fuel in Fuel tank. Fuel pump inoperative. Fuel line air leak between tank and fuel pump. Fuel line clogged. Fuel tank cap vent clogged.	Fill fuel tank. Replace pump. Repair or replace line. Disconnect and blow out lines. Clean vent.
Fuel reaches carburetor, but does not reach cylinders.	Choke does not close. Fuel passage in carburetor clogged. Carburetor float valve stuck closed.	Free-up and lubricate, inspect for proper operation. Clean or replace carburetor. Clean or replace carburetor.
High fuel consumption	Lubricant in power train too heavy. Incorrect adjustment of carburetor. Vehicle overloaded. Tires improperly inflated. Tight brakes.	Use correct lubricant. Adjust carburetor. Reduce loads to specified maximum capacity. Inflate tires properly. Adjust brakes.
Low Fuel Pressure.	Air leak in fuel lines. Fuel pump defective, diaphragm broken; valve leaking, linkage worn. Fuel lines clogged.	Tighten connections, repair lines if damaged. Replace fuel pump Clean or replace lines.
Engine idles too fast.	Improper carburetor throttle stop adjustment. Carburetor control sticking. Control return spring weak.	Adjust throttle stop screw. Free-up and lubricate control. Replace spring.
Fuel gauge does not register.	Loose wire connection at instrument panel or tank unit. Instrument panel unit or tank unit inoperative.	Tighten connections. Replace unit.



# INDUSTRIAL TRUCK DIVISION



## TROUBLE SHOOTING GUIDE

### COOLING SYSTEM

TROUBLE	PROBABLE CAUSE	REMEDY
Overheating.	Unusual operating conditions of high temperature.	Inspect. (Refer to "Engine overheats".)
Loss of cooling solution.	Loose hose connections. Damaged or deteriorated hose. Leaking radiator.	Tighten hose connections. Replace hoses. Repair or replace radiator.
Engine operates too cool.	Thermostat sticking. Low air temperature.	Replace thermostat and gasket. Cover radiator.
Noises.	Frayed or loose fan belt. Water pump defective.	Replace or adjust belt. Replace pump.

# THE ENGINE COOLING SYSTEM

Trouble spots resulting from service neglect

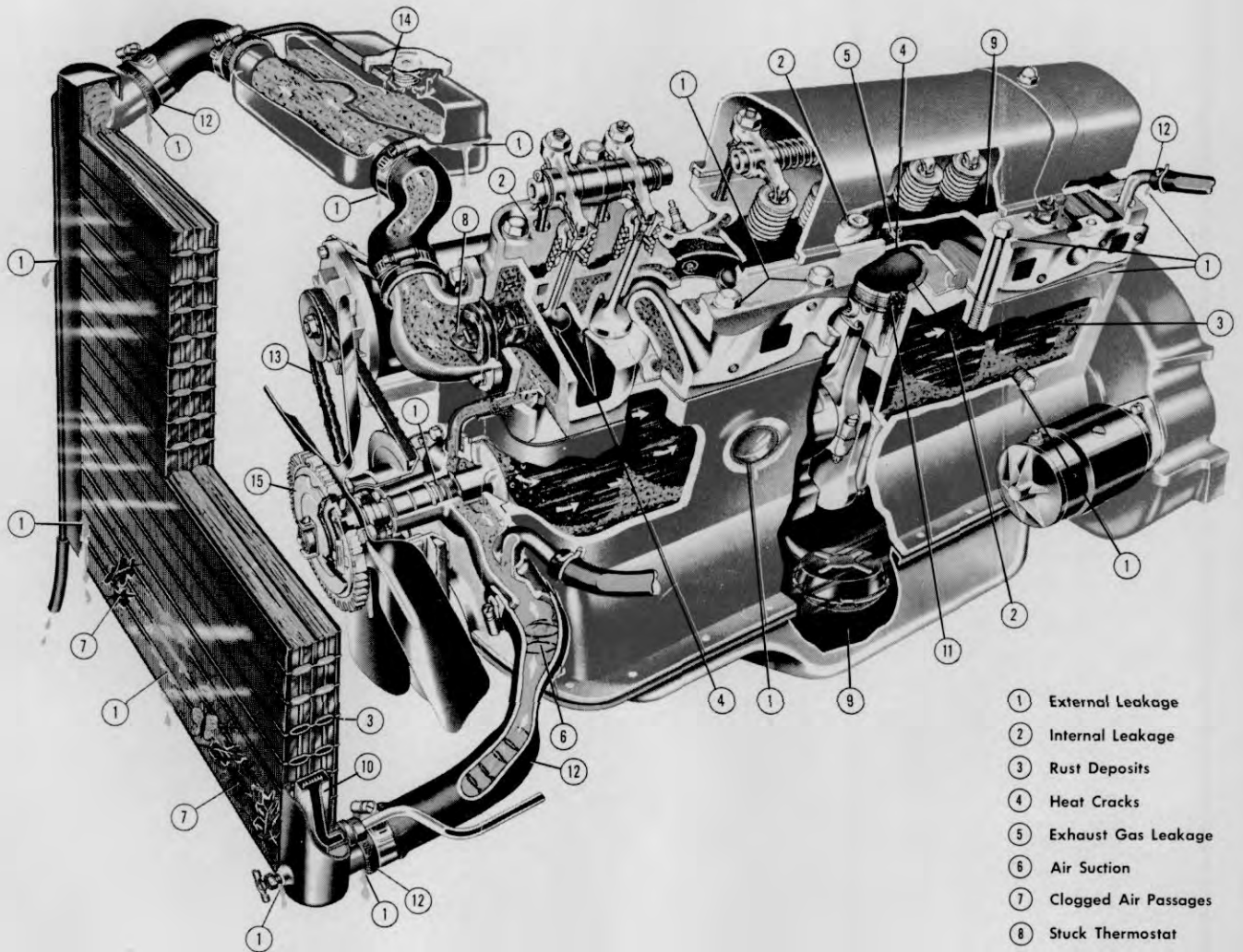

- ① External Leakage
- ② Internal Leakage
- ③ Rust Deposits
- ④ Heat Cracks
- ⑤ Exhaust Gas Leakage
- ⑥ Air Suction
- ⑦ Clogged Air Passages
- ⑧ Stuck Thermostat
- ⑨ Sludge Formation in Oil
- ⑩ Transmission Oil Cooler
- ⑪ Heat Damage
- ⑫ Hose Failure
- ⑬ Worn Fan Belt
- ⑭ Pressure Cap Leakage
- ⑮ Temperature Control Fan Drive

The cooling system depicted here does not represent that of any particular make of car; it incorporates features used by many different manufacturers.

All Rights Reserved.  
No Part of This Chart May Be Reproduced Without Permission From Union Carbide Corporation.

## Cooling System Care Pays!

This chart is distributed as a public service by  
**UNION CARBIDE CONSUMER PRODUCTS COMPANY**

UNION CARBIDE Division of Union Carbide Corporation



INDUSTRIAL TRUCK DIVISION



OPERATORS

MAINTENANCE

PARTS

MANUAL

FOR

CY-60

CLARK EQUIPMENT COMPANY

PUBLISHED BY

TECHNICAL SERVICE DEPARTMENT  
BATTI, CREB, WICHMAN, U.S.A.



# INDUSTRIAL TRUCK DIVISION



## TROUBLE SHOOTING GUIDE

### IGNITION SYSTEM

TROUBLE	PROBABLE CAUSE	REMEDY
Ignition System troubles.	<p>Weak spark.</p> <p>Timing incorrect.</p> <p>Moisture on distributor wires, coil, or spark plugs.</p> <p>Ignition switch inoperative</p> <p>Primary or secondary wiring loose, broken, or grounded.</p> <p>Coil defective</p> <p>Distributor defective.</p> <p>Spark plug defective.</p>	<p>Refer to "Engine will not Start."</p> <p>Retime ignition.</p> <p>Clean and dry thoroughly</p> <p>Replace switch</p> <p>Service.</p> <p>Refer to "Ignition coil troubles," below.</p> <p>Refer to "Distributor troubles", below.</p> <p>Refer to spark plug troubles below.</p>
Ignition coil.	<p>Connections loose; dirty or broken external wire, wet.</p> <p>Coil defective.</p>	<p>Clean and tighten, or repair, dry thoroughly.</p> <p>Replace coil.</p>
Distributor troubles.	<p>Distributor breaker points dirty or pitted, point gaps incorrect.</p> <p>Distributor breaker point arm spring weak.</p> <p>Distributor breaker points sticking.</p> <p>Distributor automatic advance defective.</p> <p>Distributor cap or rotor shorted, cracked or broken.</p> <p>Distributor rotor does not turn.</p> <p>Condenser defective.</p>	<p>Clean, adjust or replace breaker points.</p> <p>Replace breaker point arm.</p> <p>Free-up breaker points.</p> <p>Lubricate and free-up. If seized, replace distributor.</p> <p>Replace defective parts.</p> <p>Replace broken shaft, rotor, or gear.</p> <p>Replace condenser.</p>
Spark plug troubles.	<p>Cracked, broken, leaking, or improper type.</p> <p>Spark plug wires incorrectly installed on plugs or in distributor cap.</p> <p>Spark plugs dirty; gap incorrect.</p> <p>Spark plug porcelain cracked or broken.</p>	<p>Replace spark plug.</p> <p>Install wires correctly.</p> <p>Clean, set gaps, or replace plugs.</p> <p>Replace plug.</p>



# INDUSTRIAL TRUCK DIVISION



## TROUBLE SHOOTING GUIDE

### STARTING MOTOR

TROUBLE	PROBABLE CAUSE	REMEDY
Starting motor cranks engine slowly.	<p>Engine oil too heavy.</p> <p>Battery charge low.</p> <p>Battery cell shorted.</p> <p>Battery connections corroded, broken, or loose.</p> <p>Dirty commutator.</p> <p>Insufficient brush surface contact.</p> <p>Defective starting motor.</p> <p>Starting switch defective.</p>	<p>Change to proper grade oil.</p> <p>Recharge or replace battery.</p> <p>Replace battery.</p> <p>Clean and tighten, or replace cables.</p> <p>Clean commutator.</p> <p>Free-up or replace brush.</p> <p>Replace starting motor.</p> <p>Replace switch.</p>
Starting motor does not crank engine.	<p>Engine oil too heavy.</p> <p>Starting motor, Solenoid, or cables defective; loose connections.</p> <p>Starting motor pinion gear jammed in flywheel drive gear.</p> <p>Dirty drive mechanism.</p> <p>Faulty Relay Switch.</p> <p>Ignition Fuse Blown.</p> <p>Faulty Ignition Switch.</p> <p>Faulty Neutral Starting Switch.</p>	<p>Change to proper grade oil.</p> <p>Replace or tighten loose connections.</p> <p>Remove starting motor and reinstall. Replace defective driving gear.</p> <p>Clean and lubricate drive mechanism.</p> <p>Replace Relay Switch.</p> <p>Replace Fuse.</p> <p>Replace Switch.</p> <p>Replace Switch.</p> <p>NOTE: The INDEX of this manual will list an ADJUSTABLE Neutral Starting Switch if your machine is so equipped.</p>



TROUBLE SHOOTING GUIDE

GENERATOR TROUBLES

TROUBLE	PROBABLE CAUSE	REMEDY
No output.	Regulator defective.	Replace regulator.
Low or fluctuating output.	Loose fan belt. Insufficient brush surface contact. Weak brush springs. Worn commutator. Broken or loose connections. Dirty commutator. Regulator defective. Loose or dirty connections in charging circuit.	Adjust belt. Free-up or replace brush. Replace spring. Turn commutator and undercut. Repair, tighten or replace Clean commutator. Replace regulator. Clean and tighten connections.
Excessive output.	Short circuit between field coil and armature leads. Regulator defective.	Replace generator Replace regulator.
Noisy.	Loose pulley or generator mounting. Defective bearings, or armature rubbing on field poles. Improperly seated brushes.	Tighten. Replace generator. Seat Brushes.
Generator regulator trouble.	Loose connections or mountings. Defective regulator.	Clean and tighten. Replace regulator.



# INDUSTRIAL TRUCK DIVISION



## TROUBLE SHOOTING GUIDE

### BATTERY, LIGHTS AND HORN

TROUBLE	PROBABLE CAUSE	REMEDY
Battery discharged.	<p>Battery solution level low.</p> <p>Short in battery cell.</p> <p>Generator not charging.</p> <p>Loose or dirty connections; broken cables.</p> <p>Excessive use of starting motor.</p> <p>Idle battery, or excessive use of lights with engine at idle.</p> <p>Short circuits.</p>	<p>Add distilled water to bring level above plates; inspect for cracked case.</p> <p>Replace battery.</p> <p>Inspect generator, fan belt, and regulator.</p> <p>Clean and tighten connections; replace cables.</p> <p>Tune up engine; charge battery.</p> <p>Recharge or replace battery. Use lights sparingly.</p> <p>Replace defective wiring.</p>
Battery (other troubles)	<p>Overheated battery.</p> <p>Case bulged (or out of shape).</p>	<p>Inspect for short circuit or excessive generator charge.</p> <p>Inspect for overcharging and over-tightening of hold-down screws.</p>
Light switch.	<p>Loose or dirty connections; broken wire.</p> <p>Defective switch.</p>	<p>Clean and tighten; replace broken wire.</p> <p>Replace switch.</p>
Wiring.	<p>Loose or dirty connections; broken wire or terminal.</p>	<p>Clean, tighten, repair or replace. Wire or terminal.</p>
Lights do not light.	<p>Switch not fully "on".</p> <p>Loose or dirty connections; broken wire.</p> <p>Wiring circuit short-circuited, or open.</p> <p>Light burned out.</p>	<p>Turn switch "on" fully.</p> <p>Clean and tighten; replace or repair wire or terminal.</p> <p>Correct short circuit or replace defective parts.</p> <p>Replace light.</p>
Lights dim.	<p>Loose or dirty connection.</p> <p>Wiring short-circuited.</p> <p>Defective switch.</p>	<p>Clean and tighten connections.</p> <p>Correct short circuit or replace defective parts.</p> <p>Replace switch.</p>



# INDUSTRIAL TRUCK DIVISION



## TROUBLE SHOOTING GUIDE

### BATTERY, LIGHTS AND HORN (Continued)

TROUBLE	PROBABLE CAUSE	REMEDY
Horn troubles.	Loose or dirty wiring connections.	Clean and tighten connections.
Horn sounds continuously.	Short-circuit in wiring between horn and horn button.	Replace wire.
Improper tone.	Loose or dirty wiring connections. Cover or bracket screws loose. Points adjusted improperly.	Clean and tighten connections. Tighten. Adjust points.
Horn will not operate.	Horn Fuse Blown. Open Circuit. Faulty Horn Relay.	Replace Fuse. Trace, repair or replace as required. Replace relay.



# INDUSTRIAL TRUCK DIVISION



## TROUBLE SHOOTING GUIDE

### DRIVE AXLE

TROUBLE	PROBABLE CAUSE	REMEDY
Continuous Axle Noise.	<p>Badly worn parts.</p> <p>Unevenly worn tires.</p> <p>Improperly adjusted wheel bearing.</p> <p>Lack of lubricant.</p>	<p>Replace worn parts with new.</p> <p>Replace tires.</p> <p>Adjust correctly.</p> <p>Add sufficient lubricant of correct grade.</p>
Axle Noise on Drive or on Coast Only.	Differential pinion gear and ring gear out of adjustment or worn excessively.	Adjust, repair or replace entire unit if conditions warrants.
Excessive Backlash in Axle Driving.	<p>Loose axle shaft drive flange cap screws.</p> <p>Flange loose on axle shaft.</p> <p>Worn splines on axle shaft at differential end.</p> <p>Differential drive pinion gear and ring gear out of adjustment or worn excessively.</p>	<p>Tighten cap screws.</p> <p>Reweld flange to shaft.</p> <p>Replace drive flange and shaft assembly.</p> <p>Adjust or replace as condition warrants.</p>
Complete Failure to Function.	<p>Broken axle shaft.</p> <p>Broken teeth on ring gear or pinion gear.</p>	<p>Replace axle shaft.</p> <p>Replace ring gear and pinion and other parts of differential necessary. Adjust ring gear and pinion gear correctly.</p>



# INDUSTRIAL TRUCK DIVISION



## TROUBLE SHOOTING GUIDE

### STEERING AXLE

TROUBLE	PROBABLE CAUSE	REMEDY
Trouble.	Damaged axle. Lubrication leaks. Incorrect caster or camber. Uneven tire wear.	Replace axle. Replace oil seals. Adjust and Replace worn parts. Inflate tires properly. Check wheel alignment.



# INDUSTRIAL TRUCK DIVISION



## TROUBLE SHOOTING GUIDE

### STEERING

TROUBLE	PROBABLE CAUSE	REMEDY
Steering difficult.	Lack of lubrication Tight steering system connections. Tight steering gear; misaligned wheels. Bent steering connecting linkage or arm. Misaligned steering gear mounting.	Lubricate. Lubricate and adjust linkage. Adjust steering gear bearings, realign wheels. Straighten or replace linkage. Adjust mounting.
Wander or weaving	Improper toe in camber or caster ( <i>axle twisted</i> ). Steering system connections or king pin bearings not properly lubricated. Loose wheel bearings. Steering gear worn or maladjusted. Steering gear mountings loose.	Replace worn parts. Adjust for proper camber and caster. Lubricate. Adjust wheel bearings. Replace worn parts and adjust bearings. Tighten mounting bolts.
Low speed shimmy or wobble.	Loose steering connections. Steering gear worn, or adjustment too loose.	Adjust and tighten linkage. Tighten mounting bolts.
Low speed shimmy or wobble.	Loose steering connections. Steering gear worn, or adjustment too loose. Loose wheel bearings.	Adjust and tighten linkage. Replace worn parts; adjust worn thrust bearings and lash adjustment. Adjust wheel bearings.
Vehicle pulls to one side.	Odd size, or new and old tires on opposite wheels. Bent steering arm or connection.	Match tires. Straighten or replace bent linkage.



# INDUSTRIAL TRUCK DIVISION



## TROUBLE SHOOTING GUIDE

### HYDRAULIC SYSTEM

TROUBLE	PROBABLE CAUSE	REMEDY
Pump not delivering oil.	Wrong direction of rotation.	Must be reversed immediately to prevent seizure and breakage of parts due to lack of oil.
	Tank oil level low.	Add recommended oil.
	Oil intake pipe or suction filter plugged.	Replace filter cartridge, clean strainer if so equipped.
	Air leak in suction line.	Will prevent priming, or cause noise and irregular action of control circuit.
	Oil viscosity too heavy to pick up prime.	Thinner oil should be used, per recommendations for given temperature and service.
	Broken pump shaft or gear.	Replace broken, worn or defective parts.
Pump not developing pressure.	Pump not delivering oil for any of the above reasons.	Check oil circulation by watching oil in tank.
	Relief valve spring broken	Replace relief valve
	Relief valve sticking open.	Dirt under pressure adjustment valve. Clean valve
	Leak in hydraulic control system (cylinders or valves).	Find leak and correct.
	Partially clogged intake line, intake filter or restricted intake pipe.	Pump must receive intake oil freely or cavitation will take place.
Pump making noise.	Small air leak at pump intake piping joints.	Test by pouring oil on joints while listening for change in operation. Tighten as required.
	Air leak at pump shaft packing.	Repair or replace.
	Tank air vent plugged.	Must be open thru breather opening or air filter.
	Too high oil viscosity.	Use recommended oils.
	Shaft packing worn.	Replace shaft packing per preceding instructions.
	Oil filter dirty.	Replace filter element.
Forks do not lift to maximum height.	Hydraulic Oil level low.	Fill sump tank.



# INDUSTRIAL TRUCK DIVISION



## TROUBLE SHOOTING GUIDE

### HYDRAULIC SYSTEM CONTINUED

TROUBLE	PROBABLE CAUSE	REMEDY
Lift or tilt action fails.	Loss of oil pressure.	See "pump not delivering oil"
Oil leak at top of lift cylinder assembly.	Worn or damaged lift piston seal. Scored cylinder wall. Plugged vent line.	Replace seal. Replace Cylinder Clean out vent line. Replace if collapsed.
Oil leak around piston rod at tilt cylinder	Worn seal. Scored piston rod.	Replace seal. Replace rod and eliminate cause of scoring which may be caused by misalignment, worn bearing or foreign matter.
With load centered on lift forks load is lifted unevenly.	Lift chains out of adjustment.	Adjust chains.





# INDUSTRIAL TRUCK DIVISION



## TROUBLE SHOOTING GUIDE

### TRANSMISSION, CONVERTER AND AXLE ADAPTER

TROUBLE	PROBABLE CAUSE	REMEDY
Machine will not move in either direction	<p>Parking brake not released.</p> <p>Control linkage not properly adjusted.</p> <p>Oil level low.</p> <p>No oil pressure.</p>	<p>Release brake.</p> <p>Readjust linkage.</p> <p>Determine cause and correct. Fill to proper level with Type "A" Automatic Transmission Fluid Armour Qualified.</p> <p>Replace Pump.</p>
Machine will move in one direction only.	<p>Control linkage not adjusted.</p> <p>No oil pressure to Directional Selector. Seals and "O" Rings in Directional Selector may be defective.</p> <p>Directional Selector Discs not releasing. Discs defective. Relief hole in D.S. Drum clogged.</p>	<p>Adjust linkage.</p> <p>Replace seals and "O" Rings.</p> <p>Replace Discs and clean all orifices.</p>
Machine moves slowly in both directions at wide open throttle.	<p>Oil level low.</p> <p>Low oil pressure. Faulty Inching Valve, Faulty Relief Valve, Faulty Pump.</p> <p>Brakes dragging.</p> <p>Clogged Sump screen.</p>	<p>Fill to correct level and determine cause for loss of oil.</p> <p>Replace defective parts.</p> <p>Adjust brakes.</p> <p>Clean Screen.</p>
Transmission overheating.	<p>Low oil.</p> <p>Low Directional Selector pressure (check with gauge). Inching valve not functioning properly.</p> <p>Seals in selector defective.</p> <p>Regulating valve sticking open.</p> <p>Brakes Dragging.</p> <p>Clogged Sump Screen.</p>	<p>Check and fill to correct level.</p> <p>Replace worn parts as necessary and clean.</p> <p>Replace seals</p> <p>Clean valve; replace worn or defective parts.</p> <p>Adjust brakes.</p> <p>Clean Screen.</p>



# INDUSTRIAL TRUCK DIVISION



## TROUBLE SHOOTING GUIDE

### TRANSMISSION, CONVERTER AND AXLE ADAPTER

TROUBLE	PROBABLE CAUSE	REMEDY
Transmission Overheating (continued)	<p>Insufficient oil to Torque Converter and Cooler.</p> <p>Cooler clogged internally stopping flow of oil.</p> <p>Bushing in Torque Converter Impeller Hub worn, allowing oil to leak out.</p> <p>Slipping Stator.</p>	<p>Add oil to proper level; check for plugged lines; replace defective parts.</p> <p>Clean Cooler.</p> <p>Replace worn or defective parts.</p> <p>Refer to Transmission Pressure Checks.</p>
Machine has full power and overheats.	<p>Overloading machine.</p> <p>Radiator core clogged externally.</p> <p>Pressure Regulator Valve sticking, giving low pressure.</p>	<p>Check Capacity loads. Never overload.</p> <p>Clean Core.</p> <p>Clean Valve; replace worn or defective parts.</p>



